

22005

FLY SCREEN
403.01GR/M
W.T-12mm

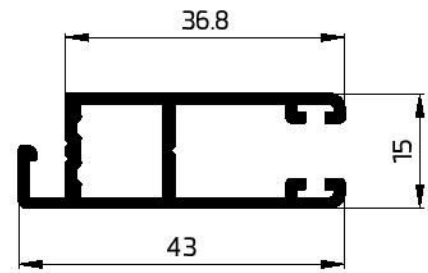

22043

FLY SCREEN
431.11GR/M
W.T-12mm

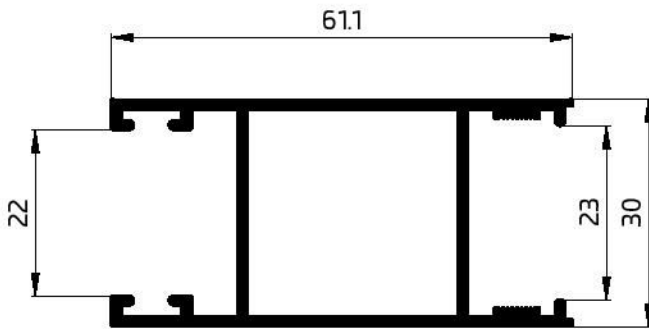

22018

SIDE SASH FOR 22020
677.30 GR/M
W.T-12mm

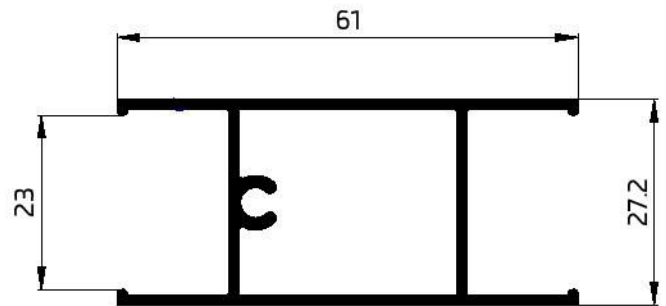

22032

DIVISOR SASH D.GLASS
671.82 GR/M
W.T-13mm

22058

SIDE SASH FOR 22060
819.86 GR/M
W.T-16mm

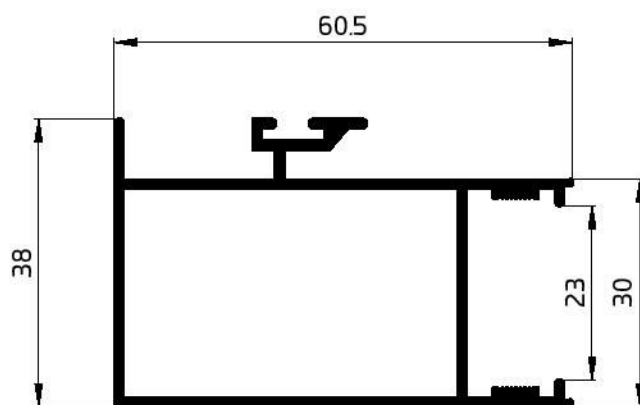

22019

INTERLOCK
SASH FOR 22020
743.71GR/M
W.T-12mm

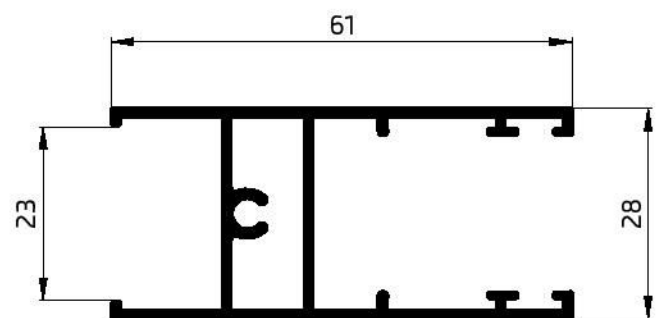

22020

RAIL SASH D.GLASS
677.41GR/M
W.T-14mm

22060

RAIL SASH D.GLASS
823.5 GR/M
W.T-16mm

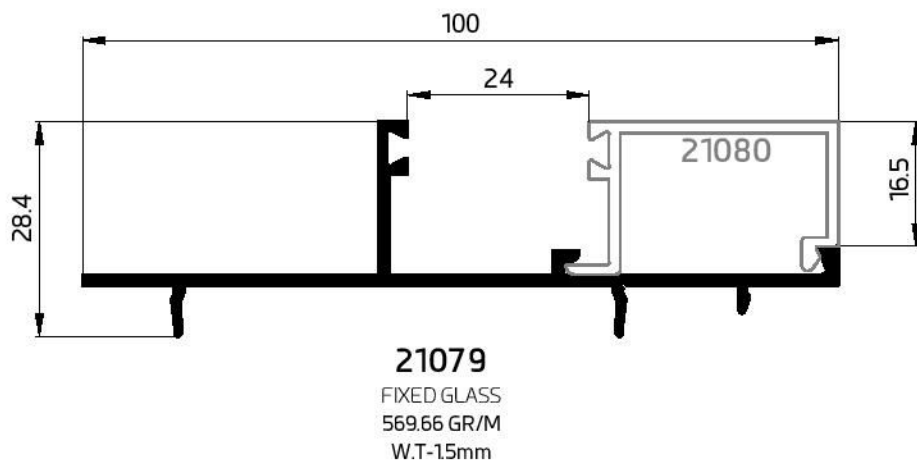
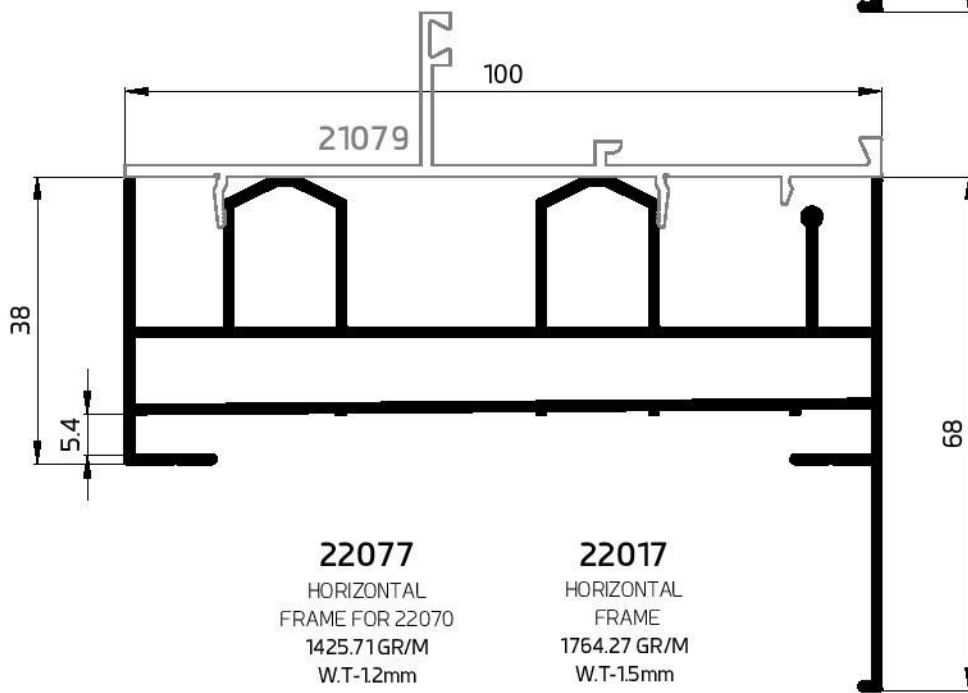
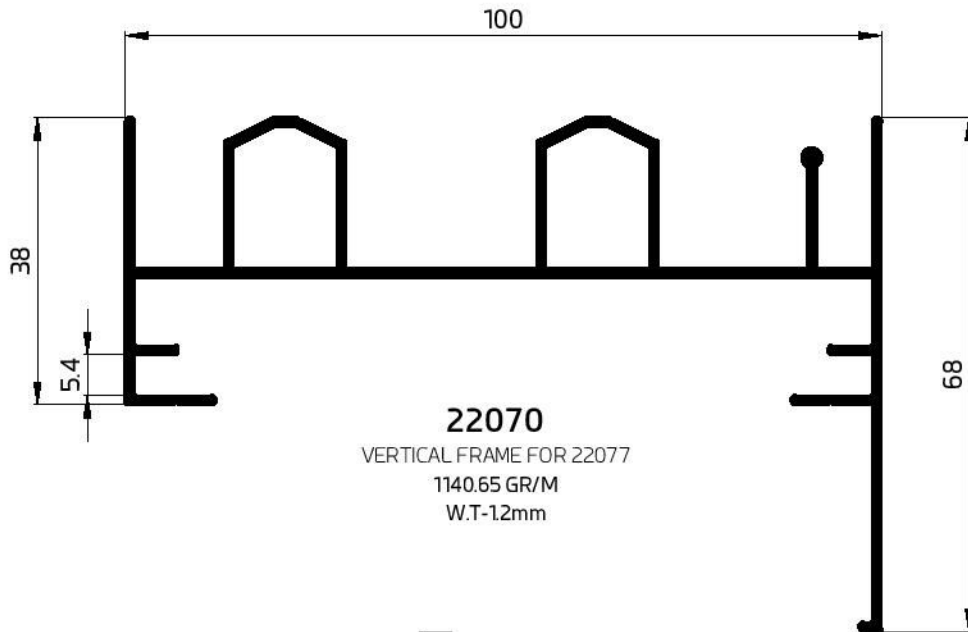

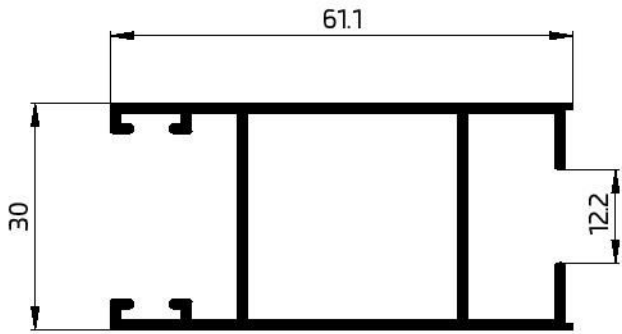

22021
 SIDE SASH FOR 22023
 734.80 GR/M
 W.T-13mm

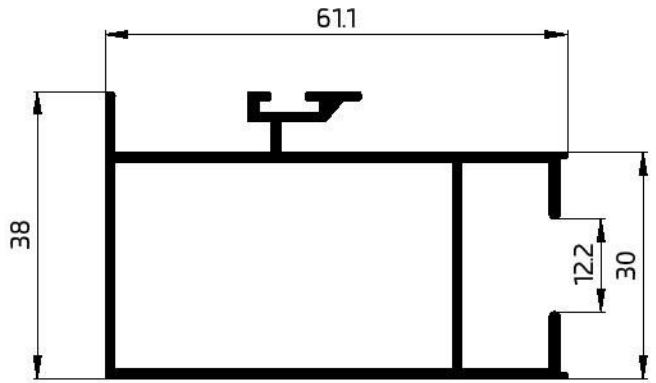

22022
 INTERLOCK SASH FOR 22023
 803.33 GR/M
 W.T-13mm

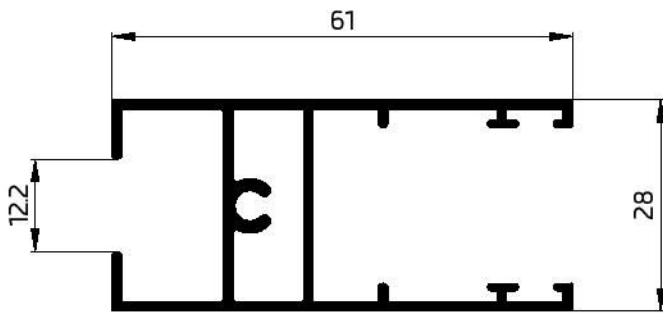

22023
 RAIL SASH S.GLASS
 779.81 GR/M
 W.T-13mm

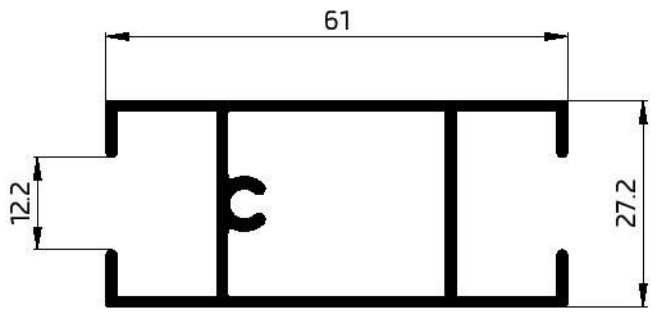

22031
 DIVISOR SASH S.GLASS
 753.68 GR/M
 W.T-13mm

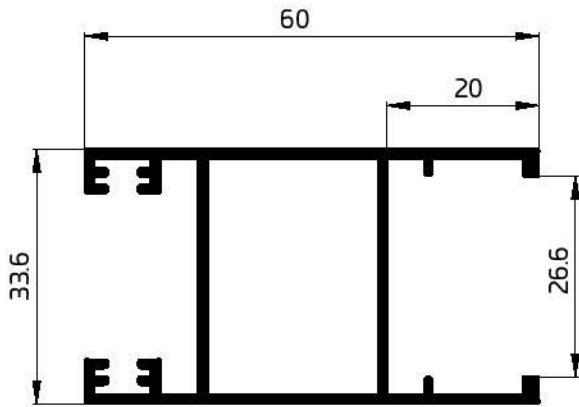

22088
SIDE SASH
728 GR/M
T-12mm

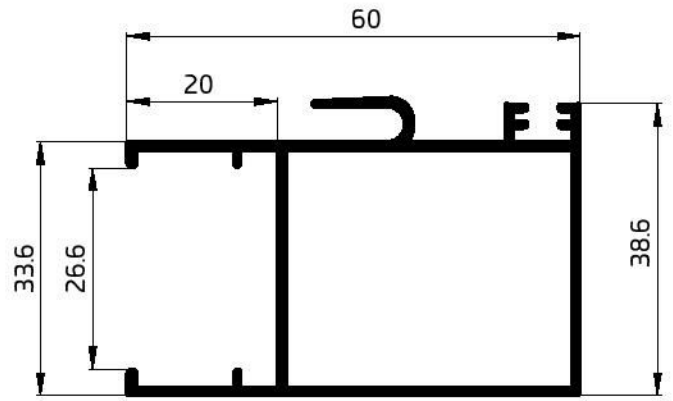

22089
INTERLOCK SASH
728 GR/M
T-12mm

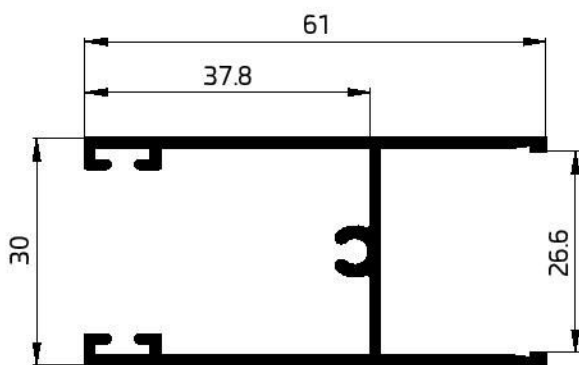

22090
RAIL SASH
588 GR/M
T-12mm

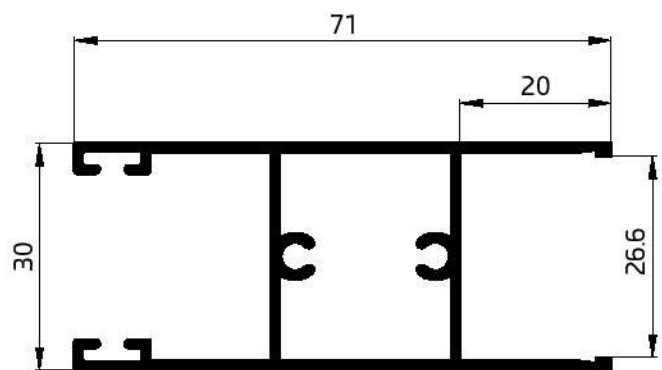

22092
TOP SASH
770 GR/M
T-12mm

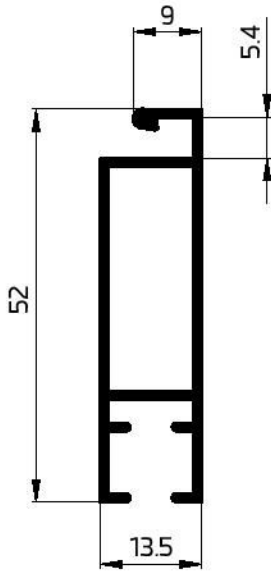

22091
 FLY SCREEN
 441GR/M
 T-115mm

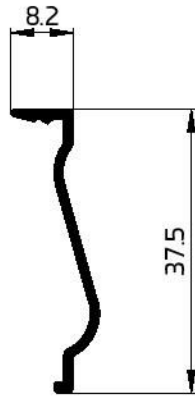

22037
 OVERLAP FOR FRAME 22036
 160.27 GR/M
 T-12mm

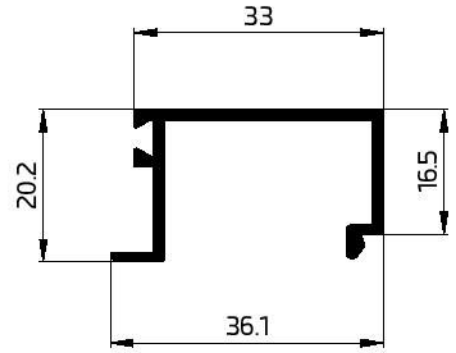

21080
 BEAD FOR FIXED GLASS
 332.38 GR/M
 T-15mm

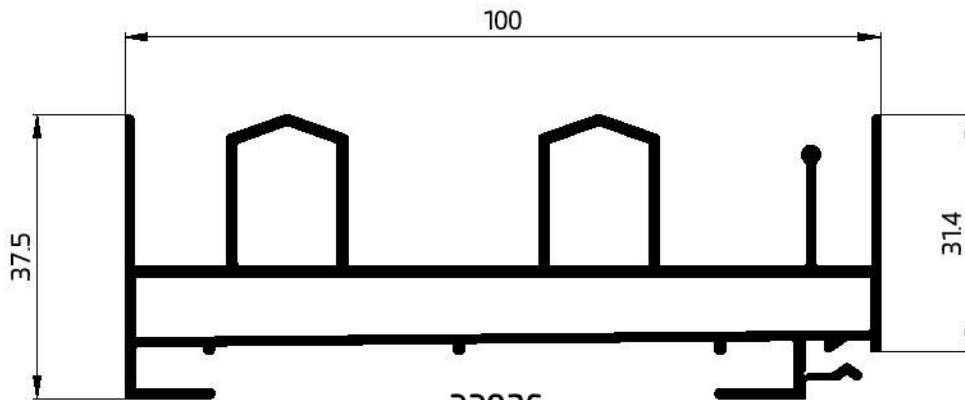

22036
 SLIDING TUBULAR FRAME 100
 1,501.63 GR/M
 T-1.4mm

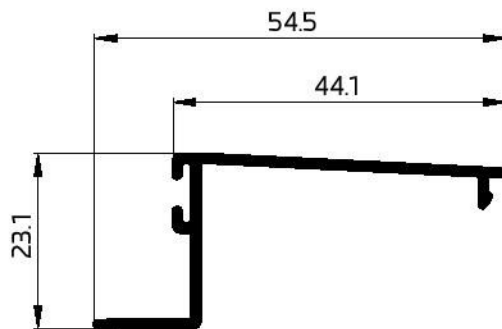

22034
BEAD FOR FIXED GLASS
275.79 GR/M
T-1.15mm

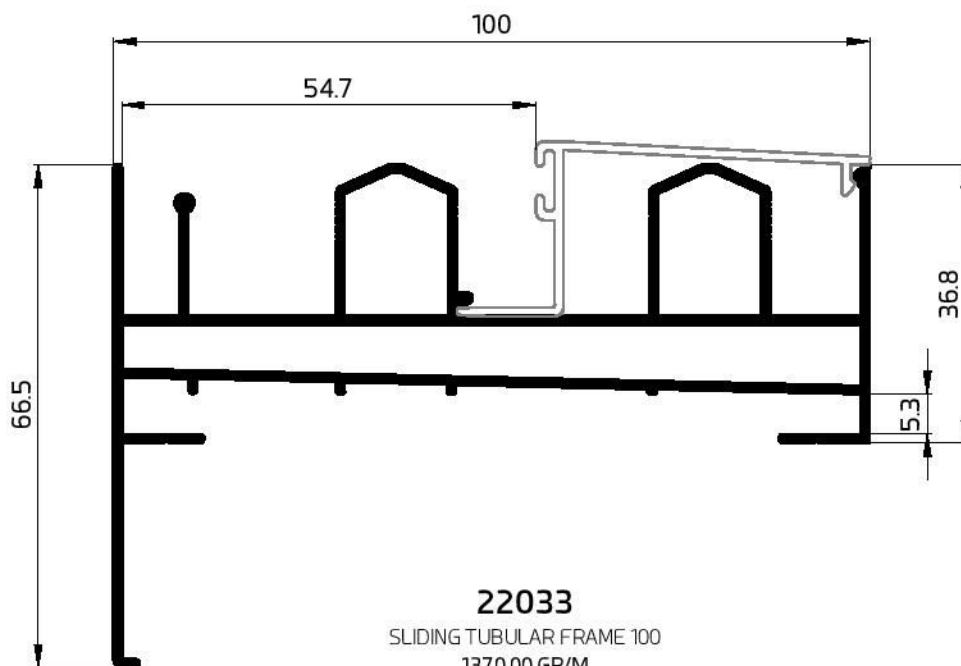

22033
SLIDING TUBULAR FRAME 100
1370.00 GR/M
T-1.15mm