

31001
FLY SCREEN
157.25 GR/M
W.T-0.9mm

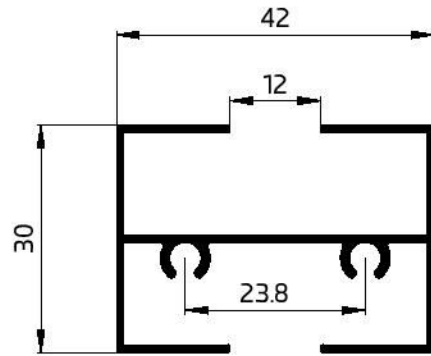

31029
DIVISOR
489.87 GR/M
W.T-1mm

31069
DIVISOR
465 GR/M
W.T-0.95 mm

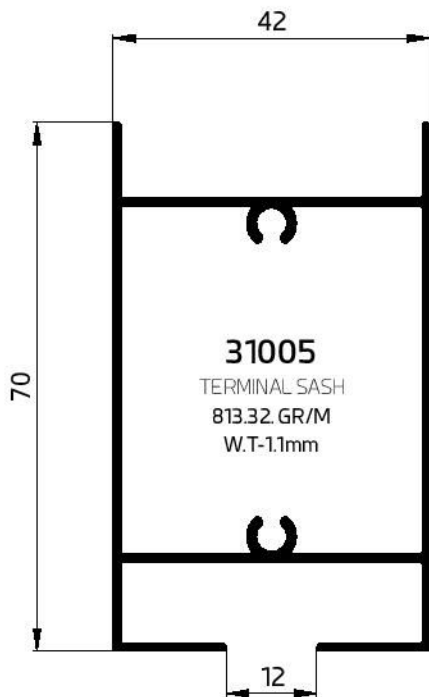

31005
TERMINAL SASH
813.32 GR/M
W.T-1.1mm

31015
TERMINAL SASH
690.00 GR/M
W.T-0.9mm

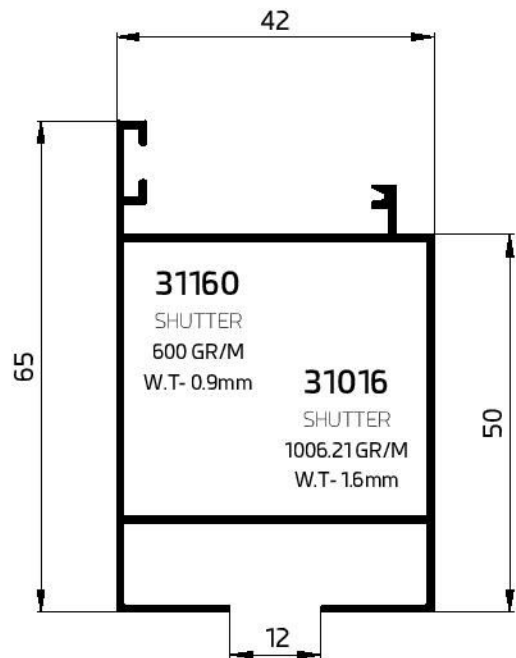

31160
SHUTTER
600 GR/M
W.T- 0.9mm

31016
SHUTTER
1006.21 GR/M
W.T- 1.6mm

31006
SHUTTER
652.94 GR/M
W.T-1mm

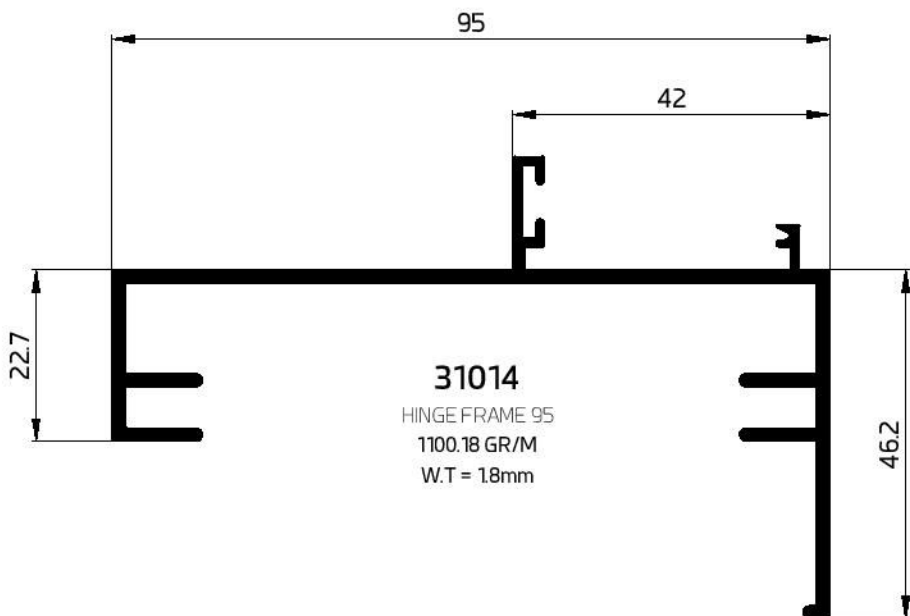
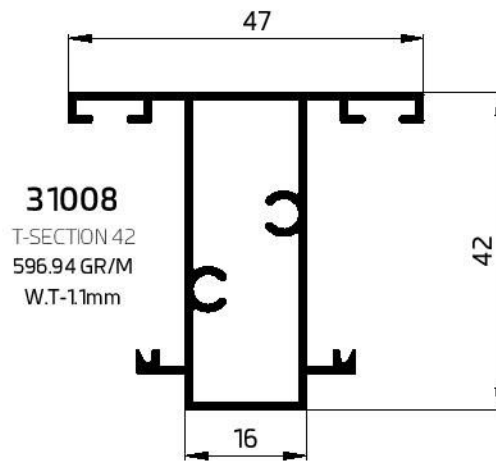
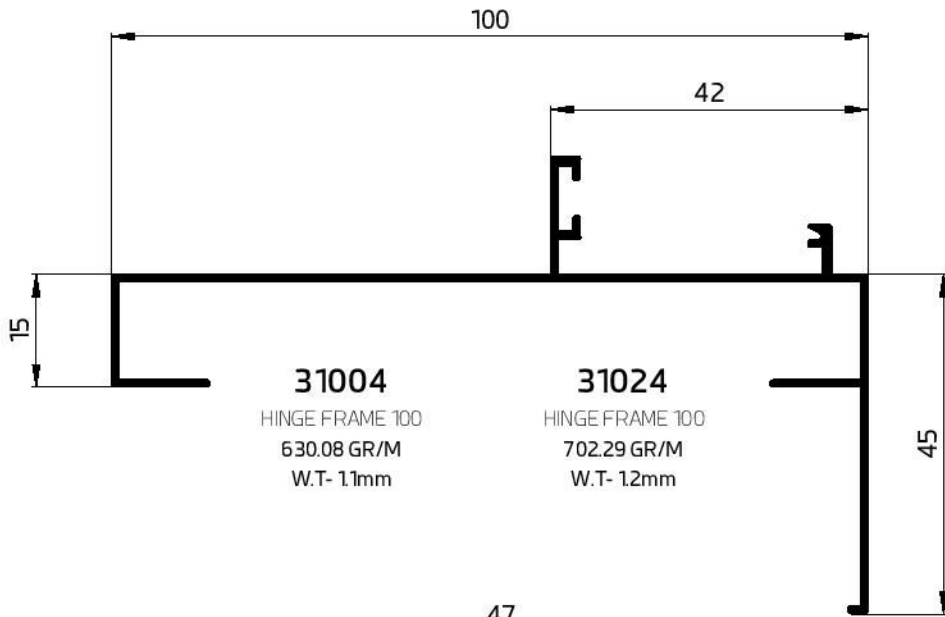

HINGED 42

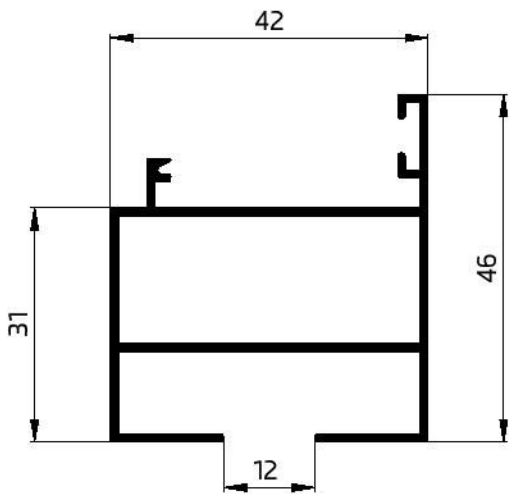

31010
SHUTTER
604.18 GR/M
W.T-1.1mm

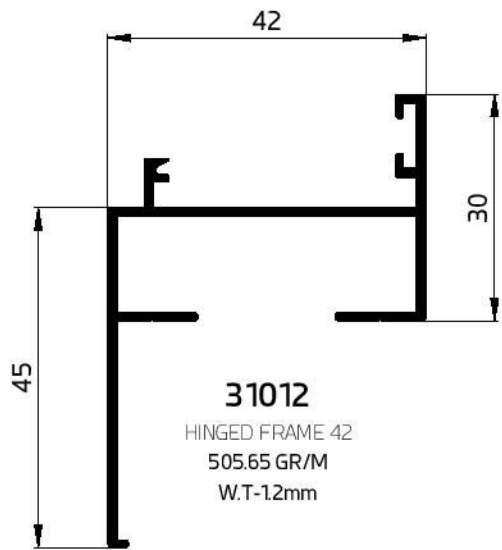

31012
HINGED FRAME 42
505.65 GR/M
W.T-1.2mm

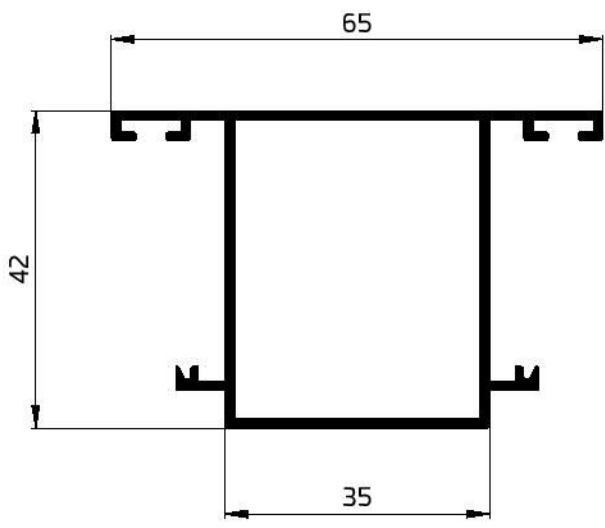

31018
T-SECTION
753.94 GR/M
W.T-1.3mm

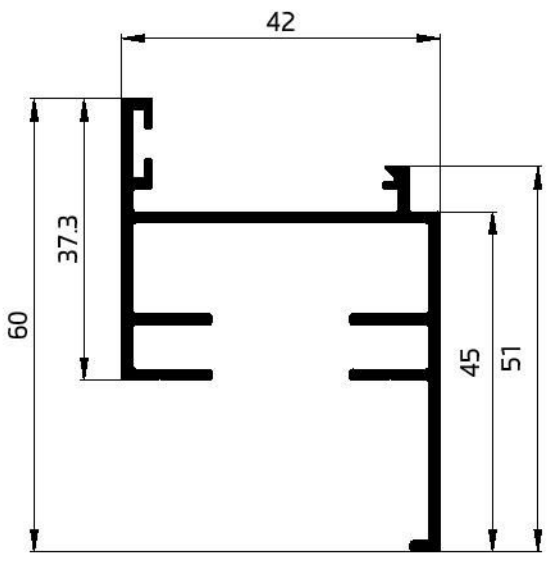

31019
HINGE FRAME 42
738.63 GR/M
W.T-1.5mm

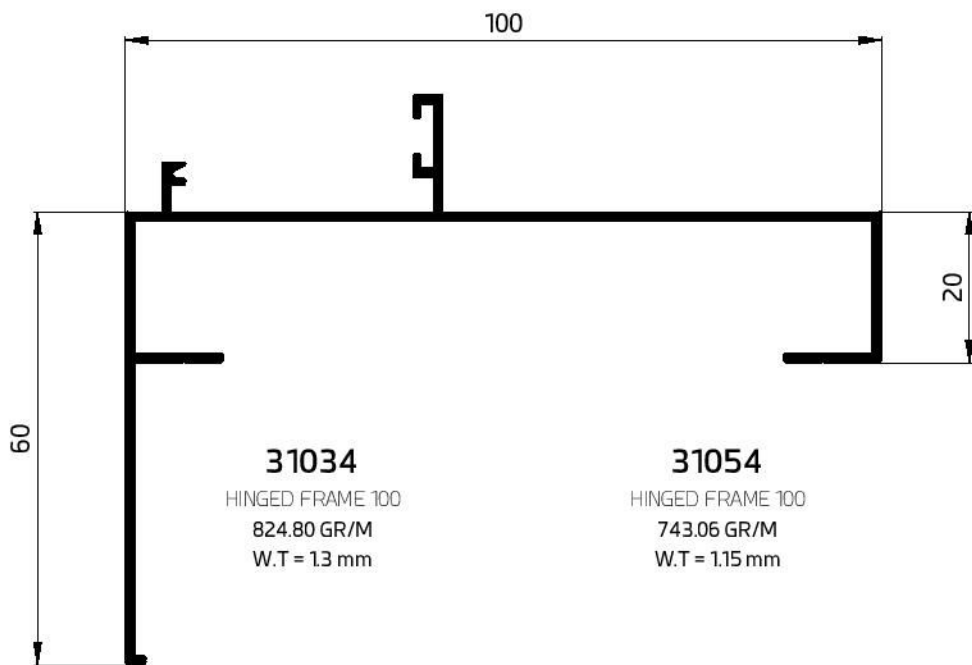
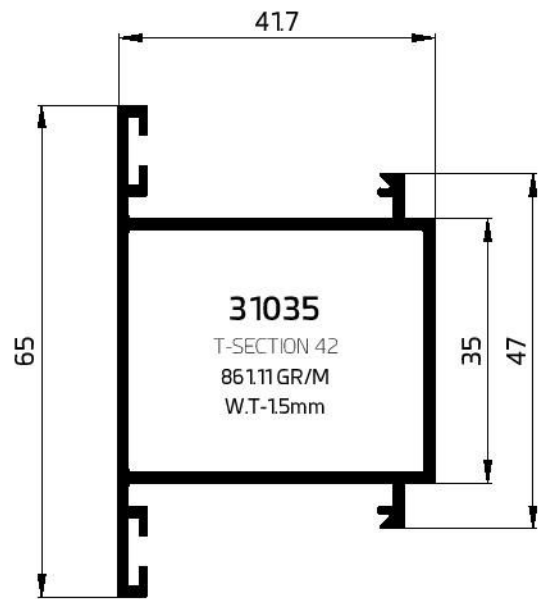
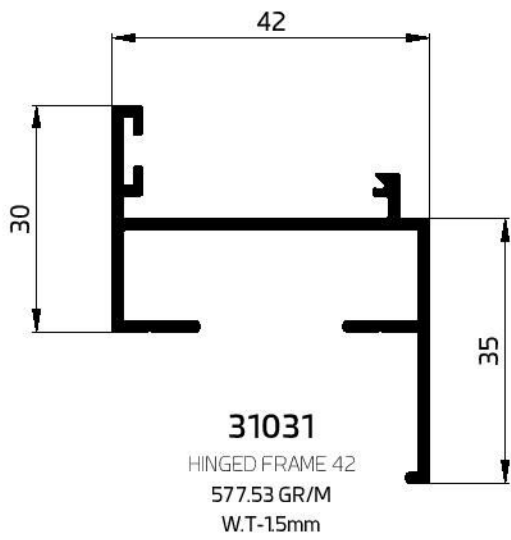

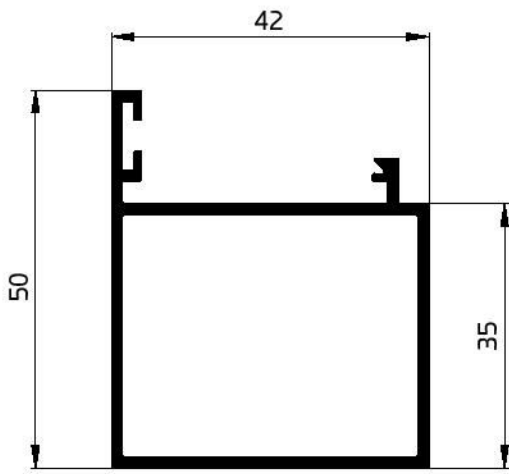

31038
 HINGED FRAME 42
 728.89 GR/M
 W.T-15mm

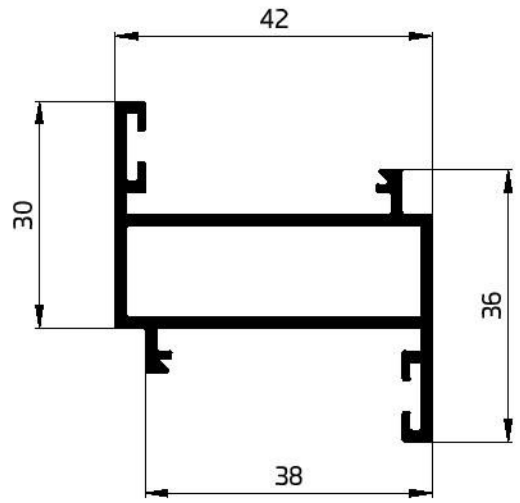

31041
 HINGED SASH 42
 696.22 GR/M
 W.T-15mm

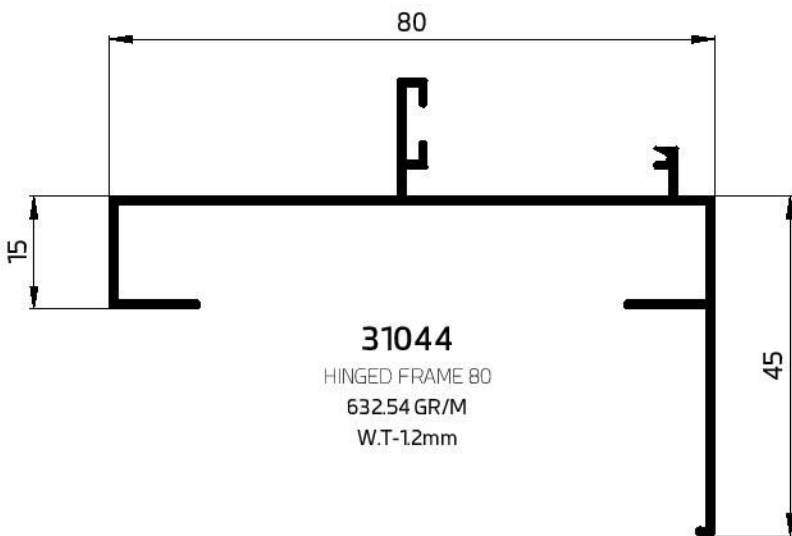

31044
 HINGED FRAME 80
 632.54 GR/M
 W.T-12mm

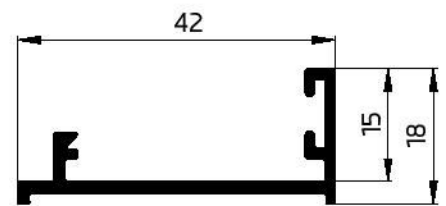

31057
 INVERTOR
 320.57 GR/M
 W.T = 16 mm

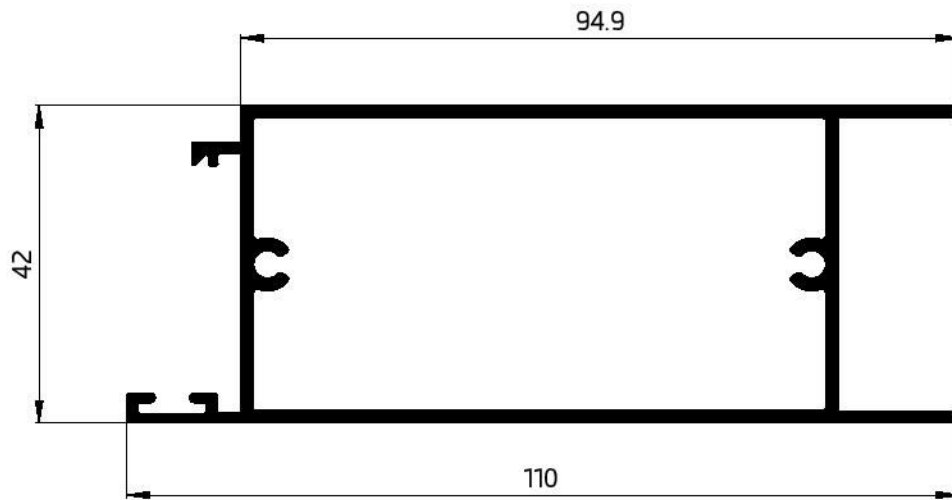

31055

HINGE TERMINAL SASH 42

1438.05 GR/M

W.T-1.7mm

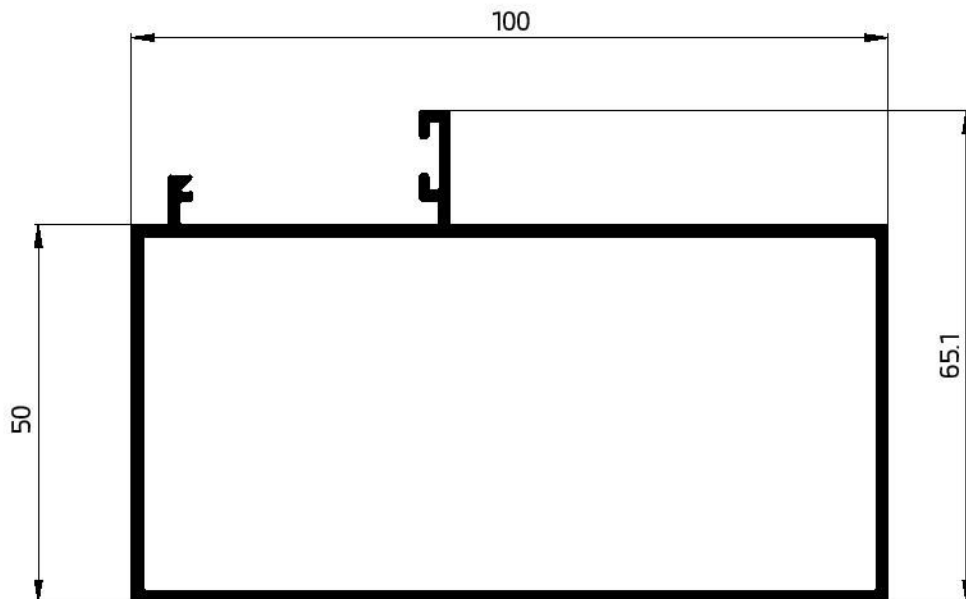

31056

HINGE FRAME 100

1401.44 GR/M

W.T-16mm

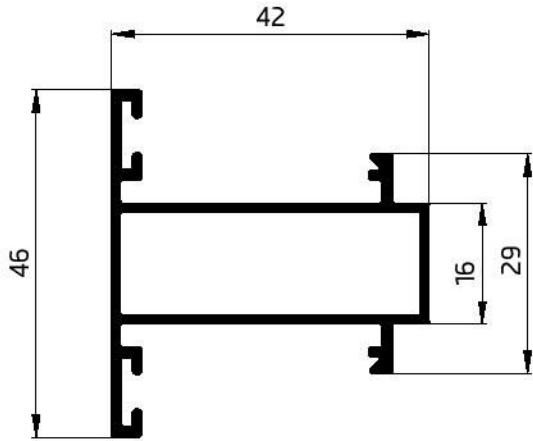

31059
 T-SECTION 42X16
 614.62 GR/M
 W.T = 12 mm

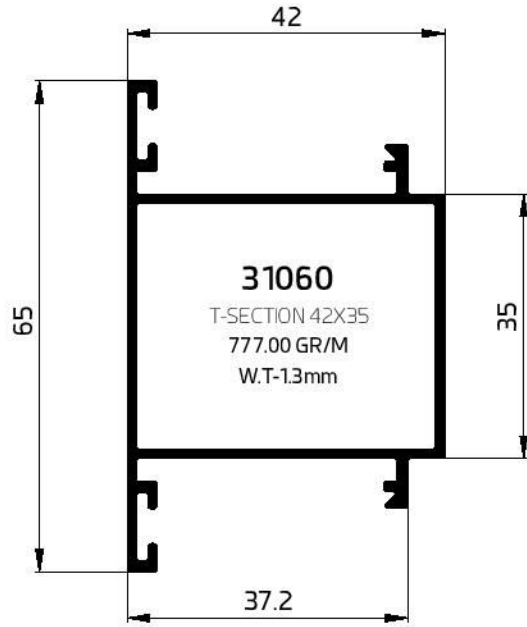

31060
 T-SECTION 42X35
 777.00 GR/M
 W.T-13mm

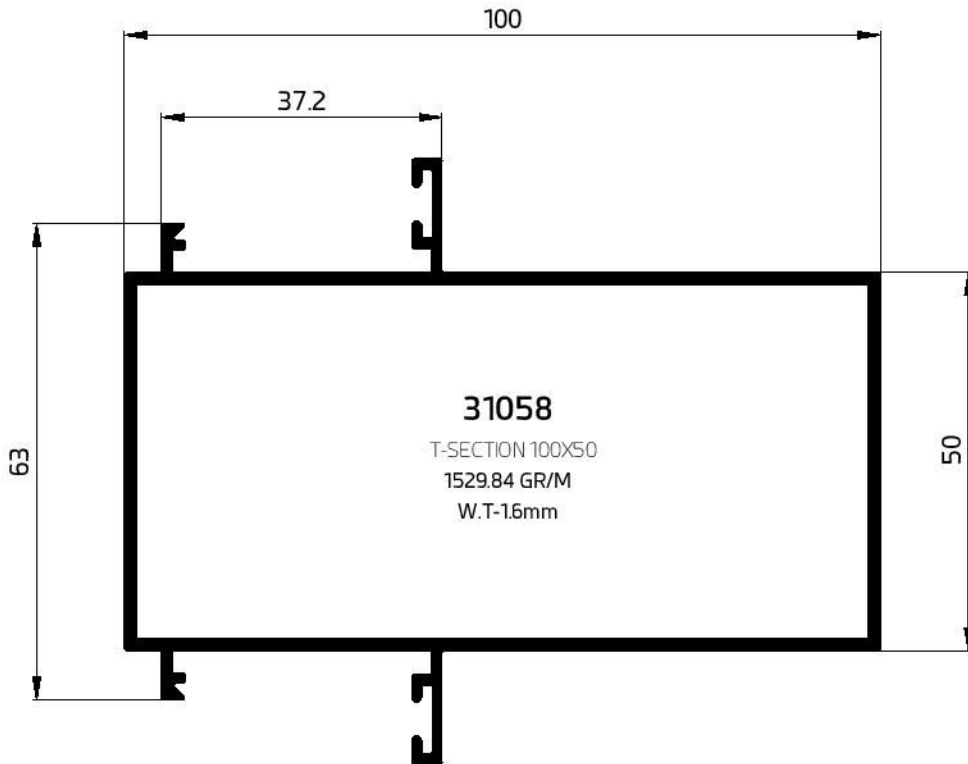

31058
 T-SECTION 100X50
 1529.84 GR/M
 W.T-16mm

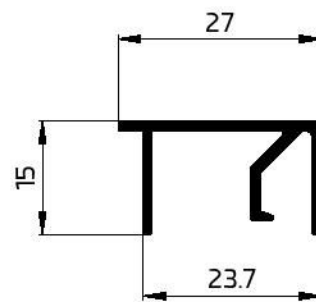
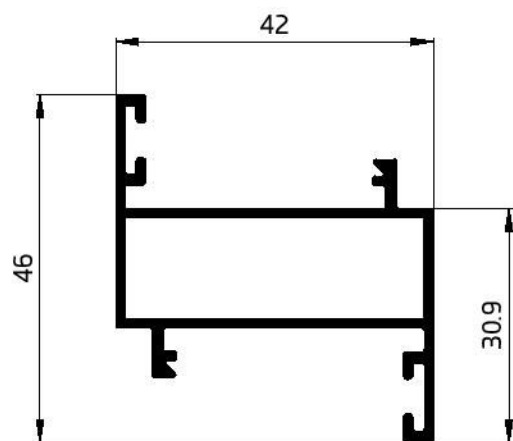
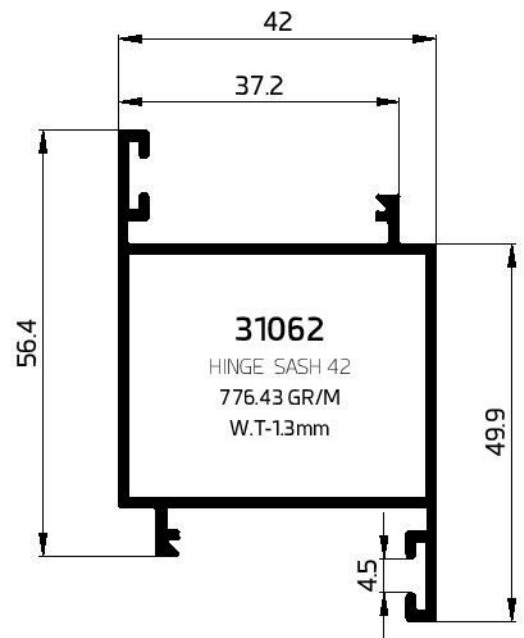
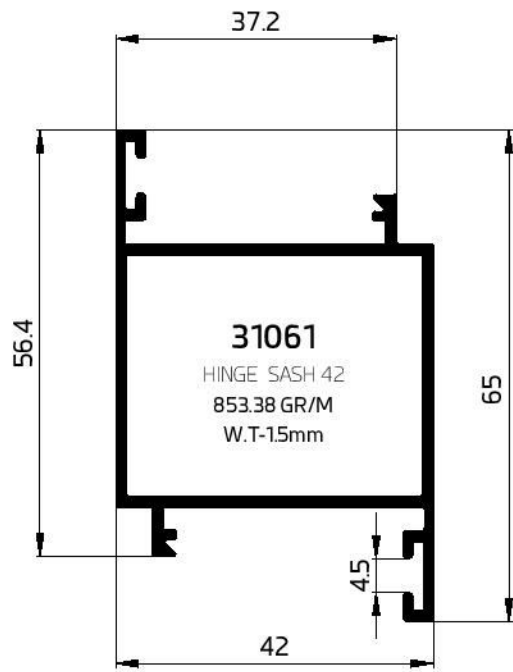

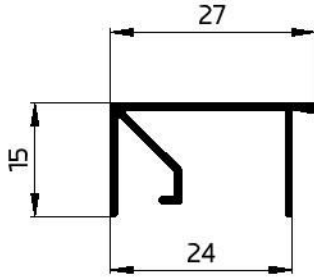

31003
 BEAD 27
 178.51GR/M
 W.T-0.9mm

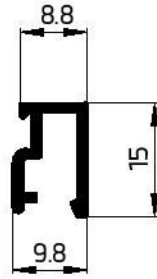

31043
 BEAD 27
 139.31 GR/M
 W.T-125mm

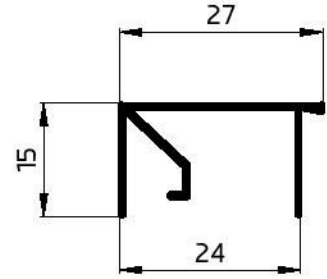

31013
 BEAD 27
 168.7 GR/M
 W.T-0.85mm

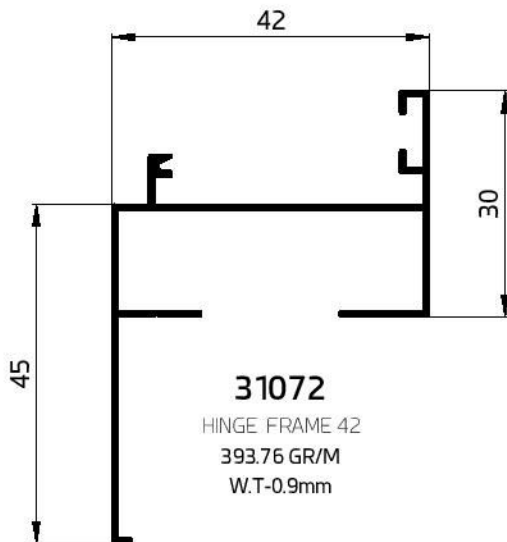

31072
 HINGE FRAME 42
 393.76 GR/M
 W.T-0.9mm

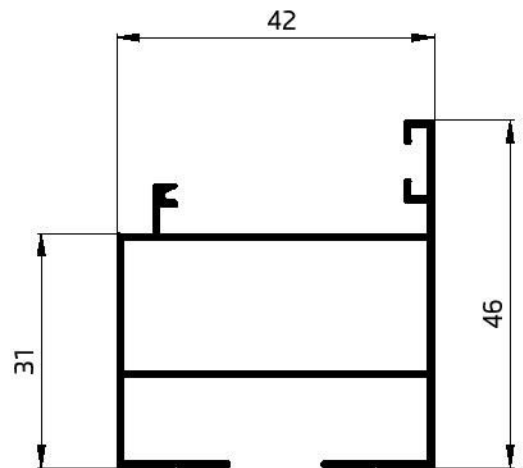

31080
 HINGE SASH 42
 500 GR/M
 W.T = 0.9 mm

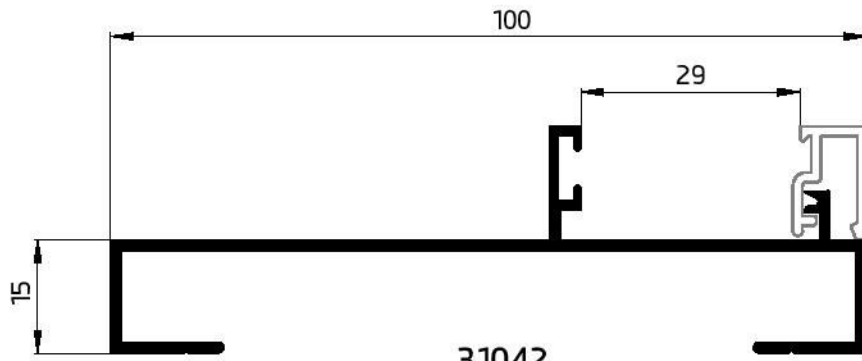

31042
 HINGE FRAME 100
 740 GR/M
 W.T-15mm

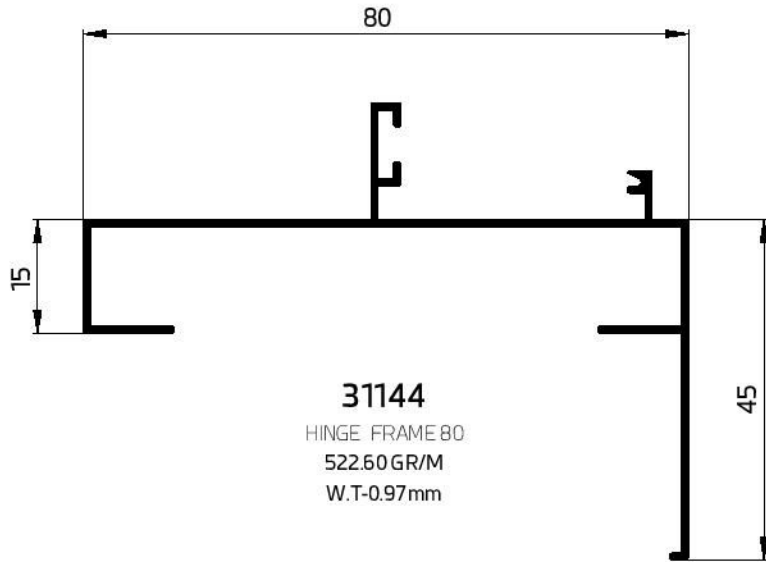

31144
 HINGE FRAME 80
 522.60 GR/M
 W.T-0.97mm

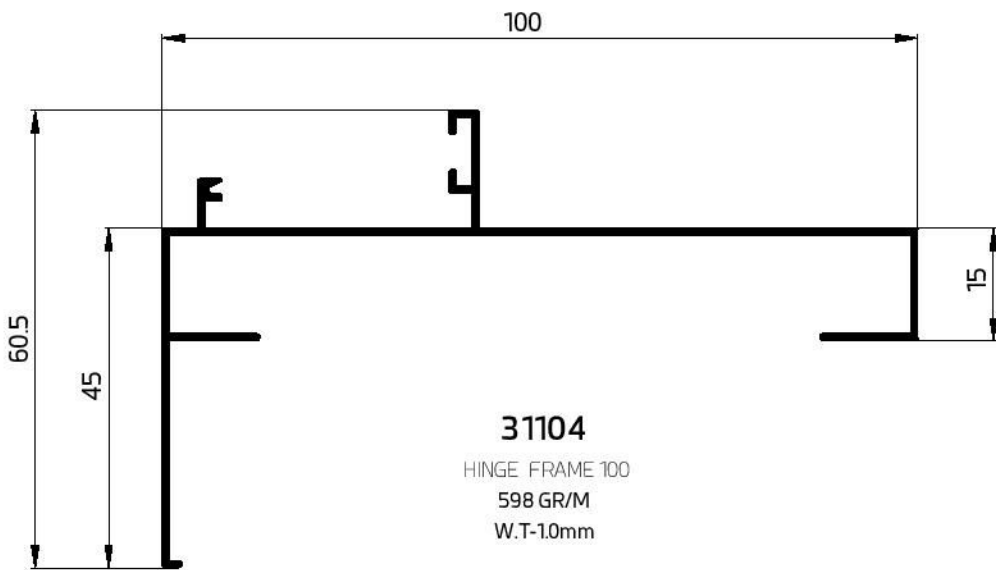

31104
 HINGE FRAME 100
 598 GR/M
 W.T-10mm