

55019

CW-MULLION/TRANSOM 615X30
1660.44 GR/M
WT-2.1mm

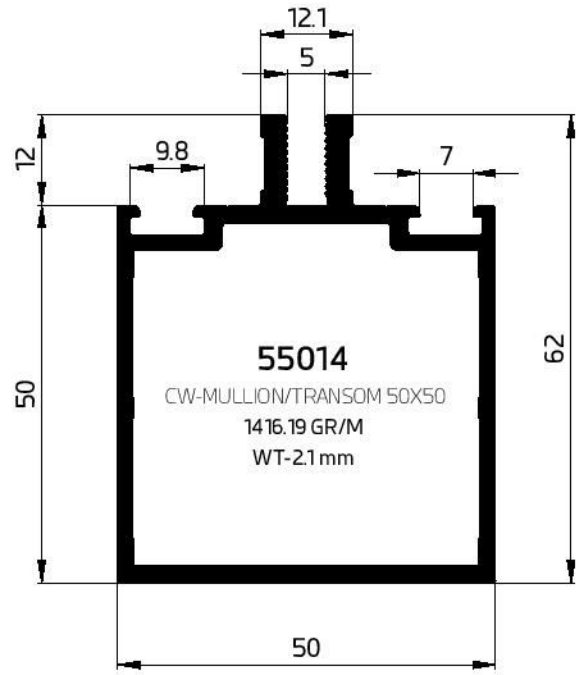

55014

CW-MULLION/TRANSOM 50X50
1416.19 GR/M
WT-2.1mm

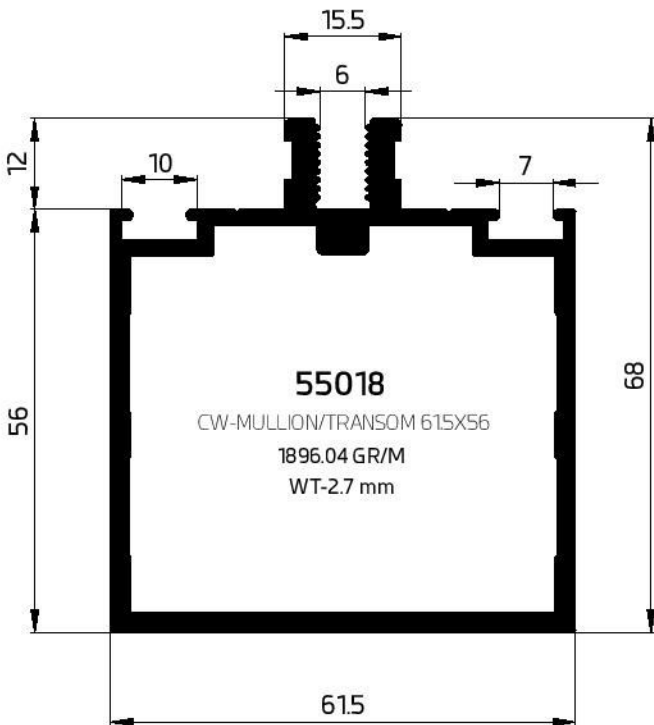

55018

CW-MULLION/TRANSOM 615X56
1896.04 GR/M
WT-2.7 mm

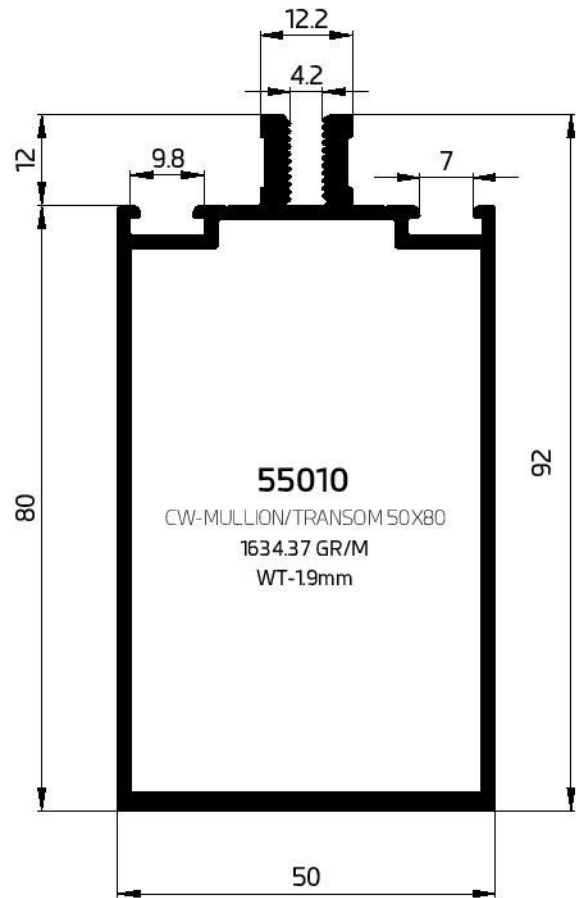

55010

CW-MULLION/TRANSOM 50X80
1634.37 GR/M
WT-19mm

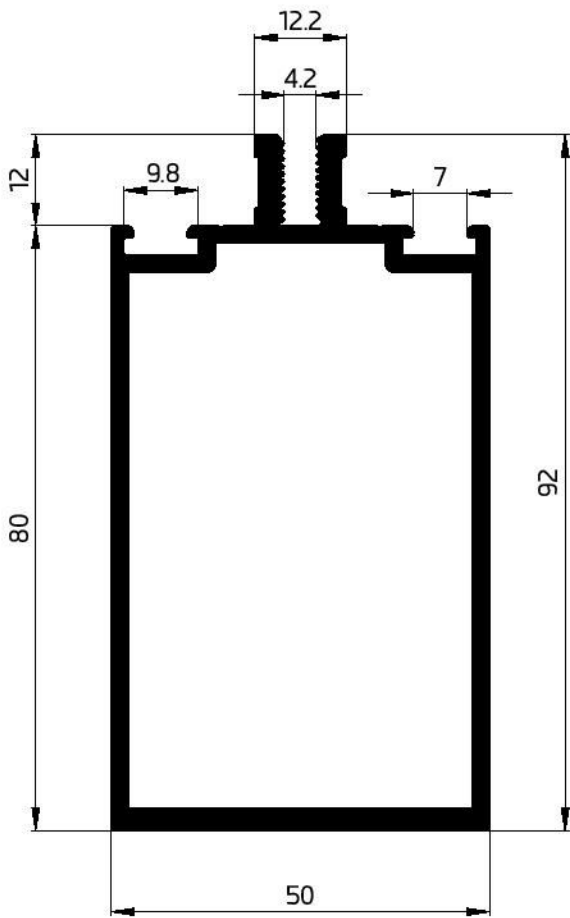

55012
 CW-MULLION/TRANSOM 50X80
 1910 GR/M
 WT-2.28mm

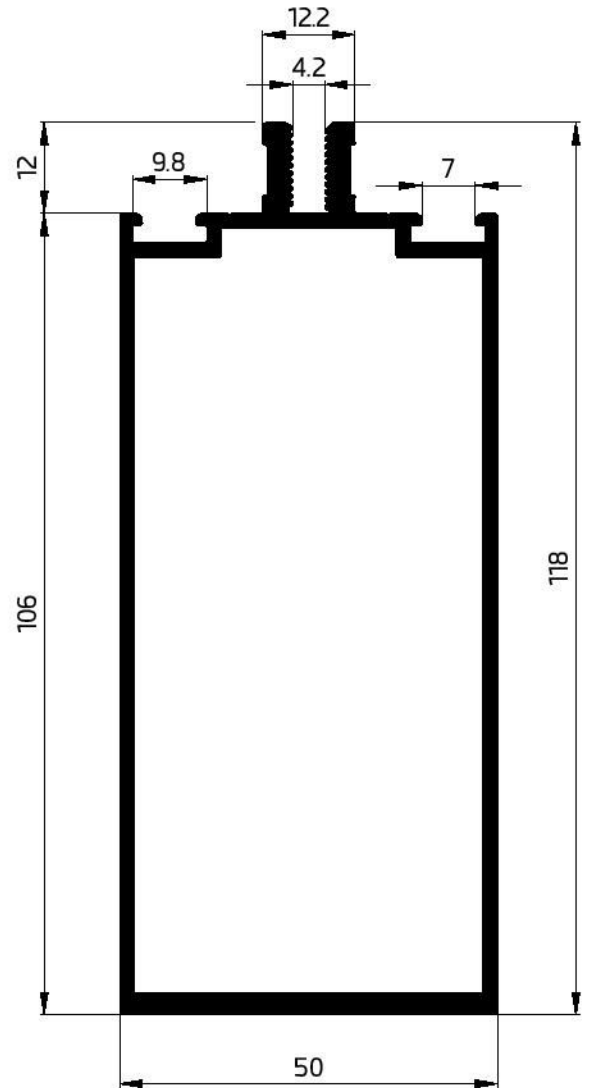

55011
 CW-MULLION/TRANSOM 50X106
 2044.81GR/M
 WT-2mm

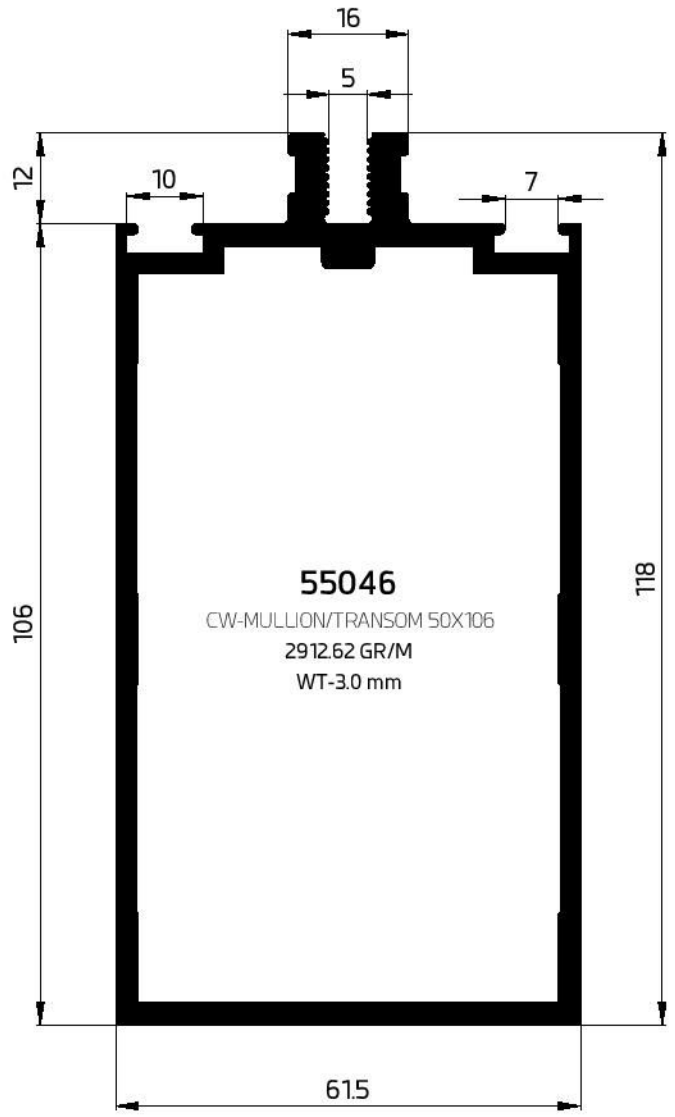
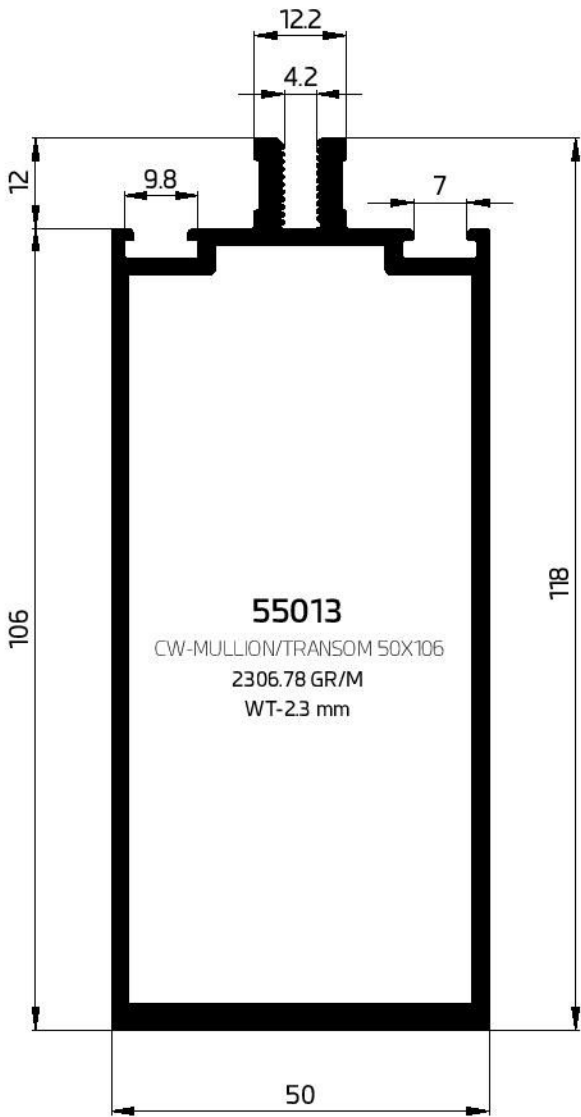

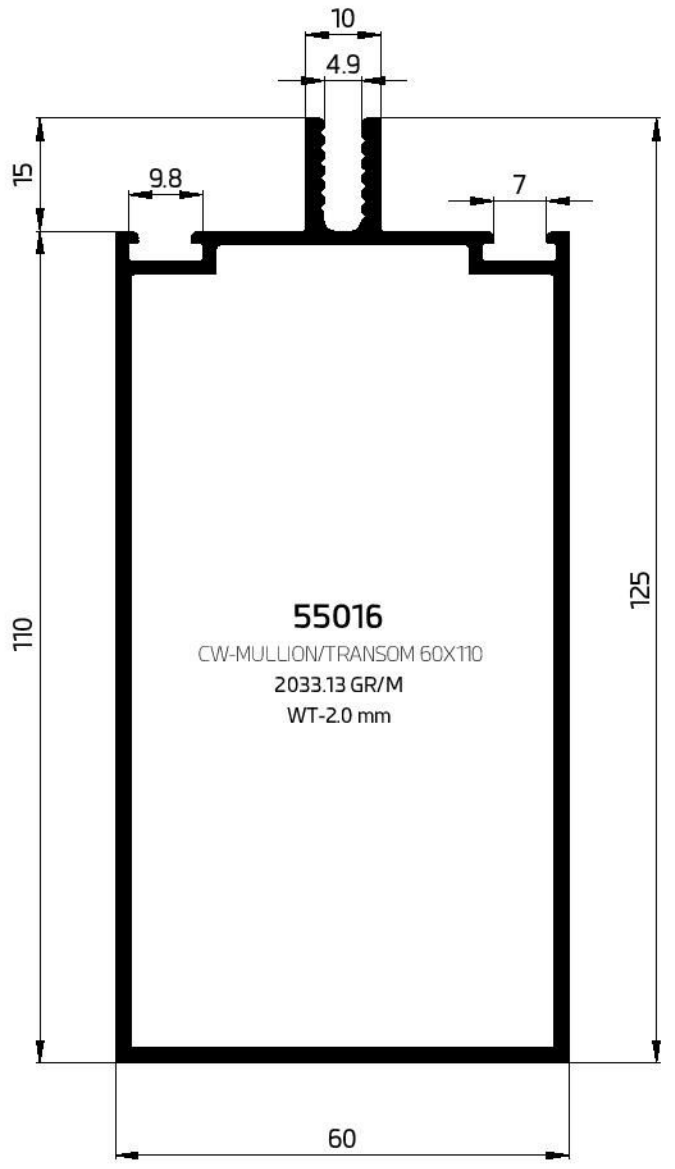
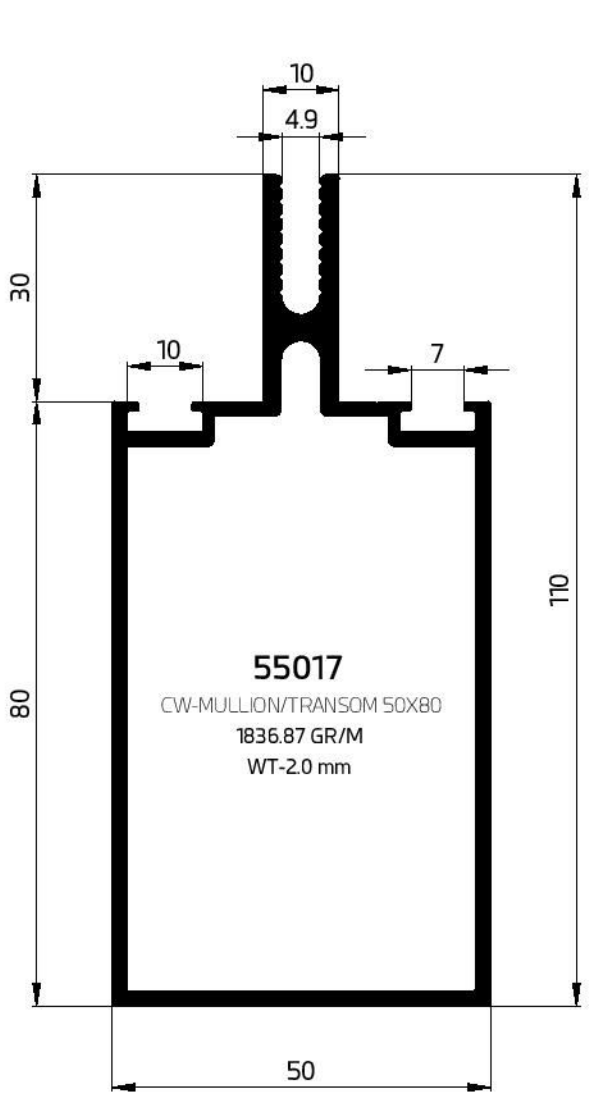

CURTAIN WALL

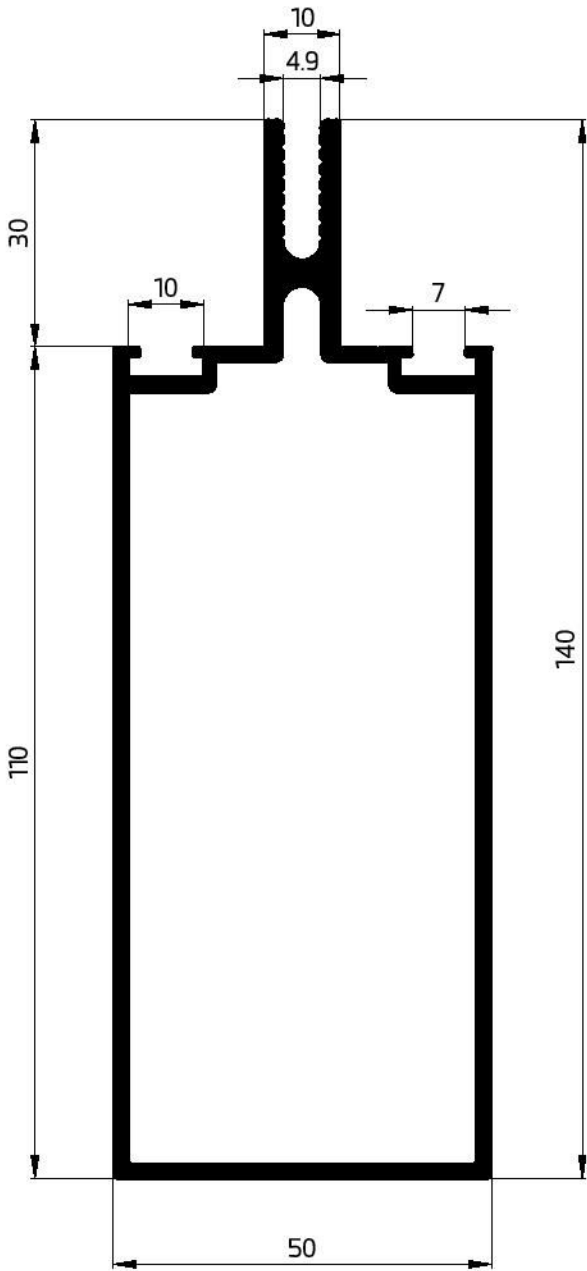

52009

CW-MULLION/TRANSOM 50X110
 2160.87 GR/M
 WT-2.0 mm

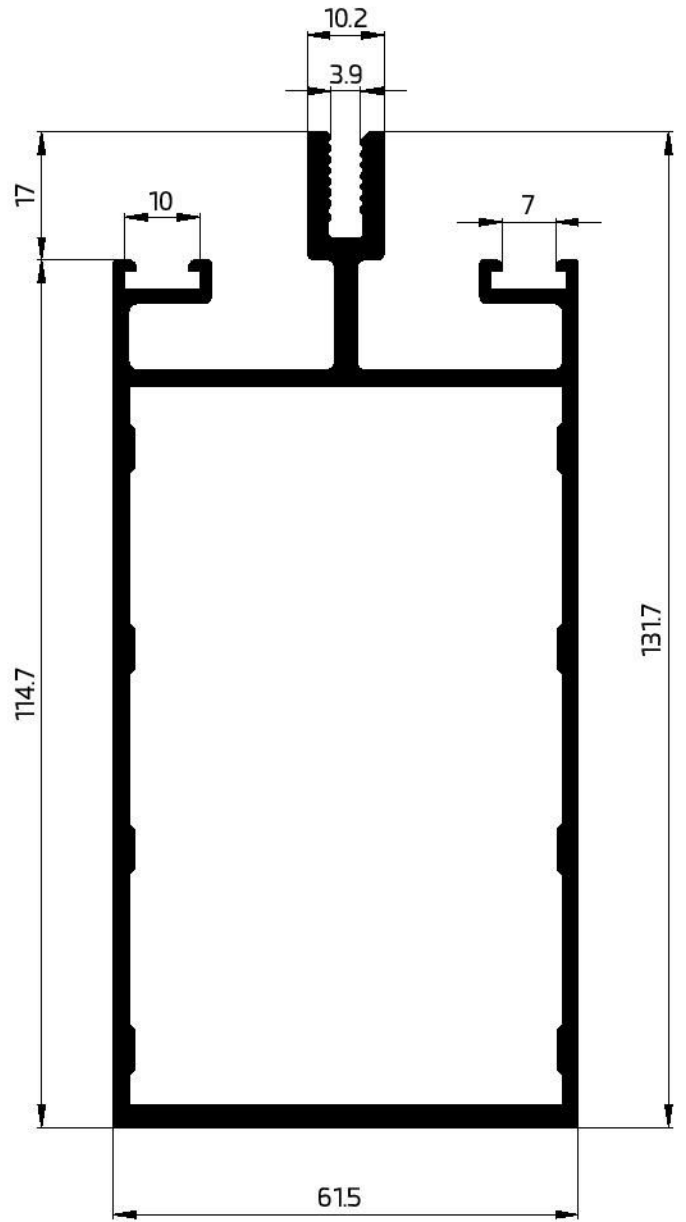

57015

CW-MULLION/TRANSOM 61.5X114.7
 2797.42 GR/M
 WT-2.15 mm

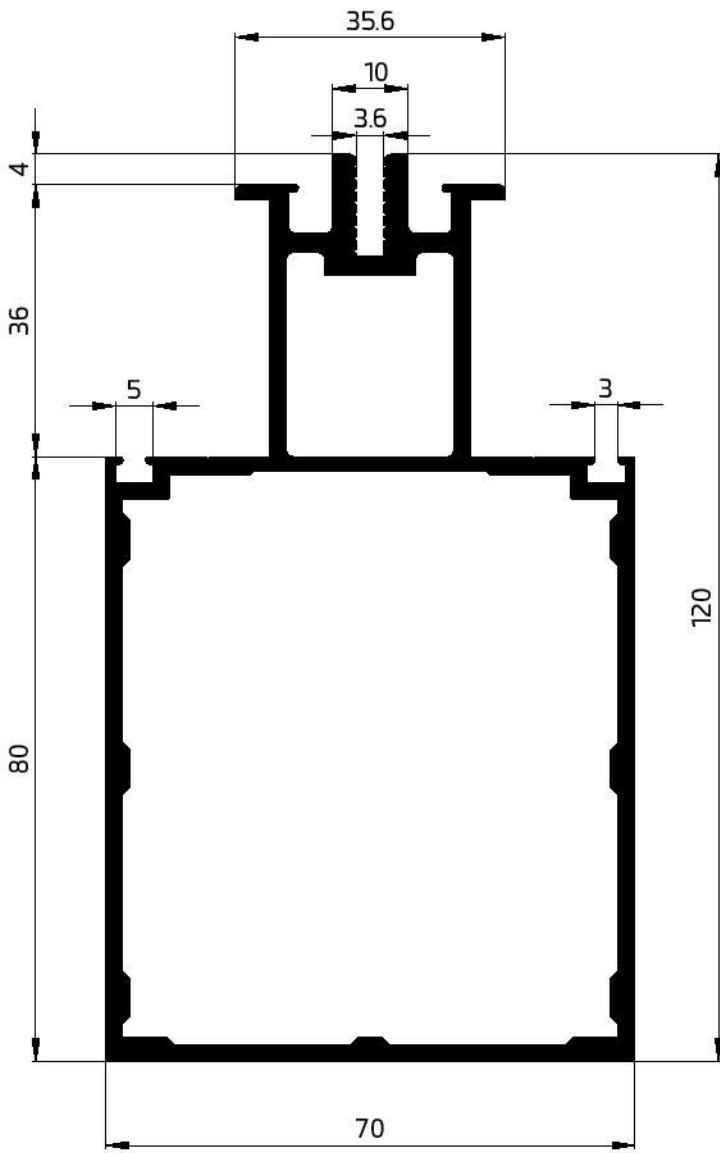

55503
 CW-MULLION/TRANSOM 70X80
 2812.91GR/M
 WT-2.2 mm

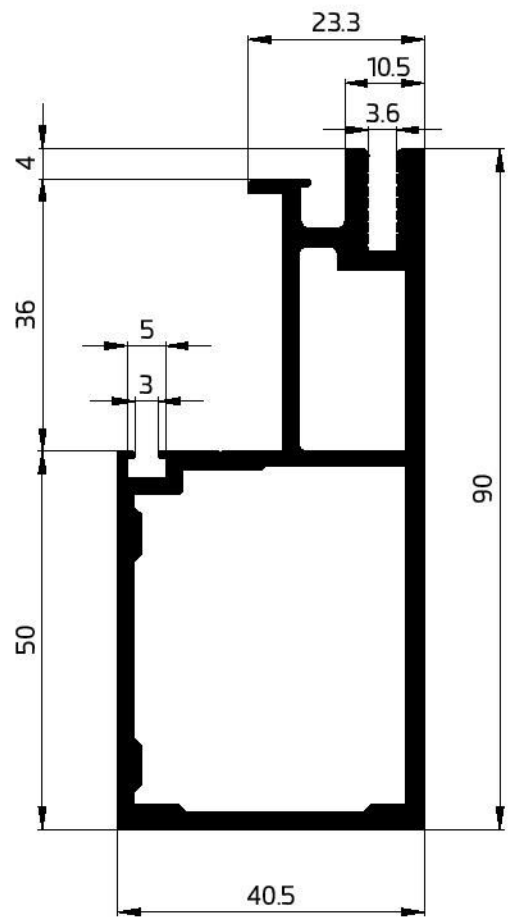

55504
 CW-END PROFILE 40.5X50
 1922.67 GR/M
 WT-2.5 mm

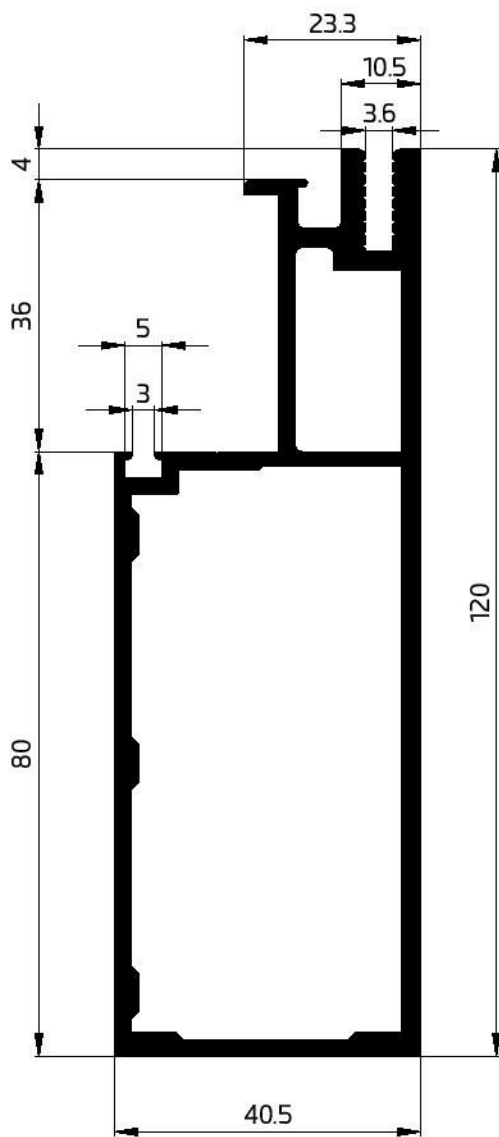

55505

CW-END PROFILE 40.5X80

2323.62 GR/M

WT-2.5 mm

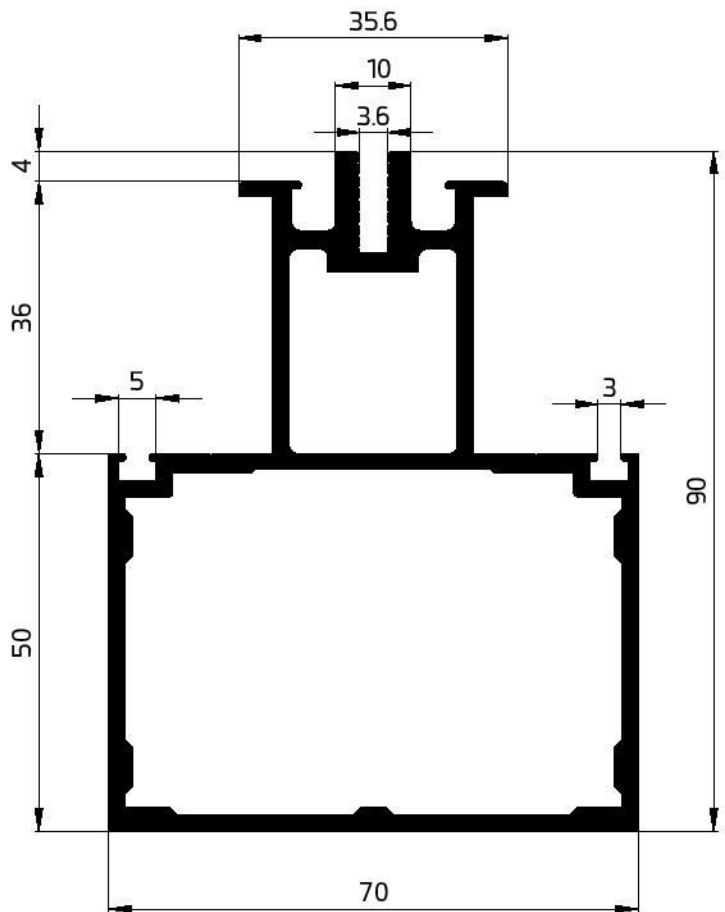

55506

CW-MULLION/TRANSOM 70X50

2424.11 GR/M

WT-2.2 mm

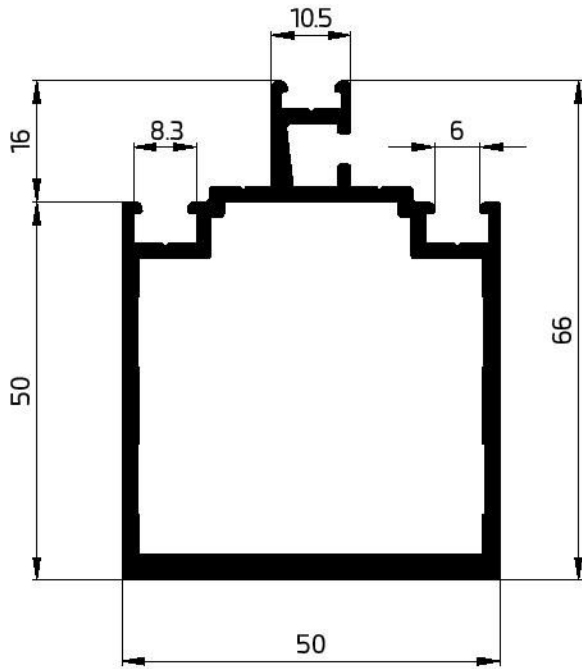

55047
 CW-TRANSOM 50X50
 1500.47 GR/M
 WT-2.15 mm

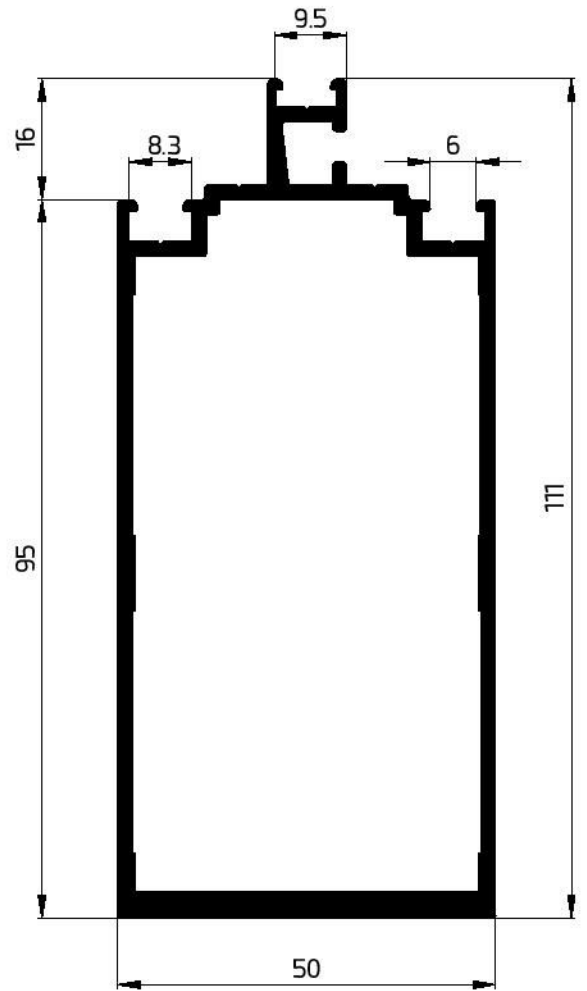

55033
 CW-TRANSOM 50X95
 1995 GR/M
 WT-2.0 mm

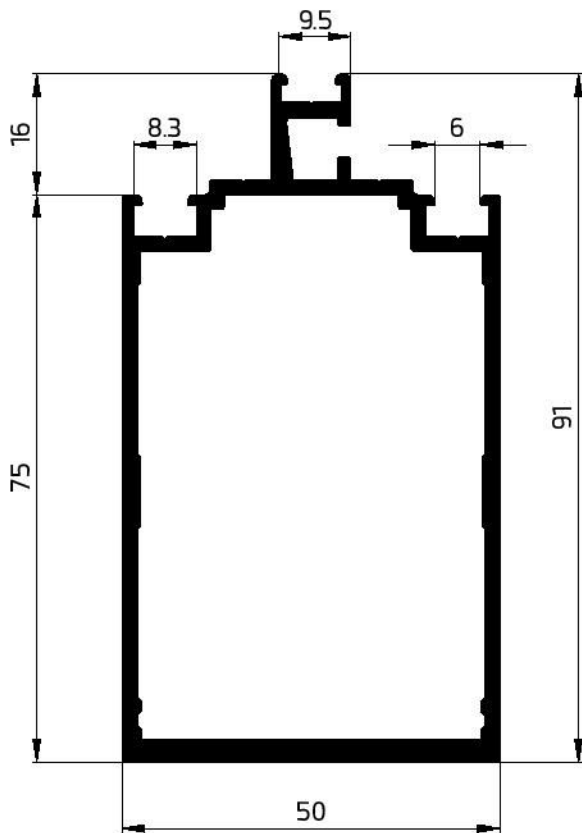

55032
 CW-TRANSOM 50X75
 1715 GR/M
 W T-2.0 mm

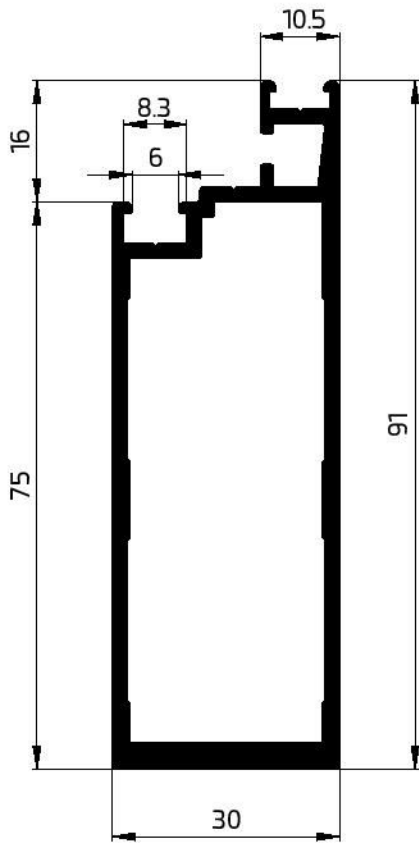

55036

CW-END TRANSOM 30X75

1448 GR/M

WT-2.0mm

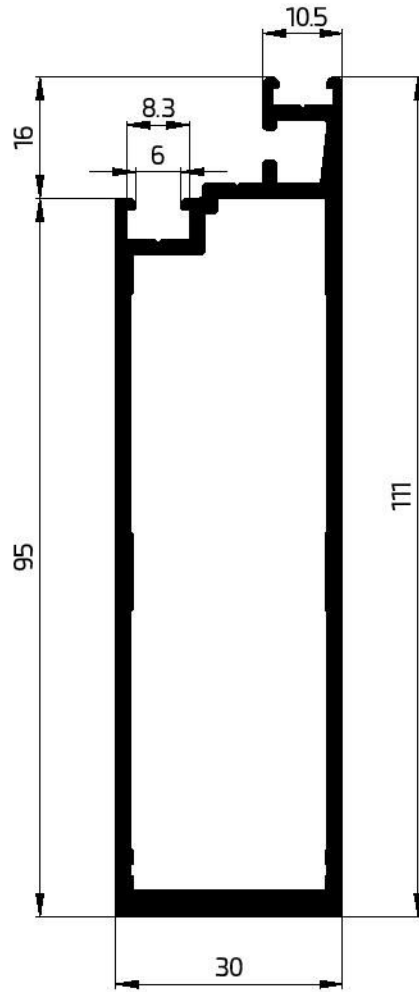

55037

CW-END TRANSOM 30X95

1661 GR/M

WT-2.0 mm

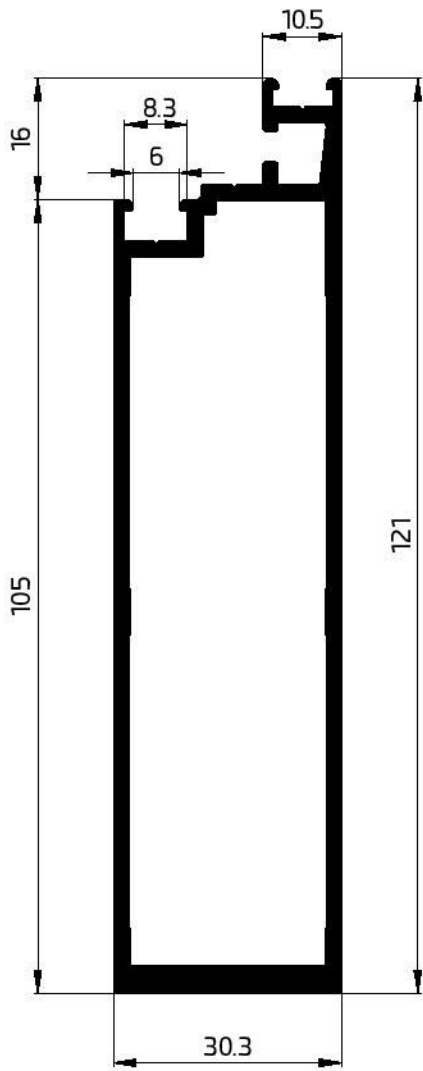

55024
 CW-END TRANSOM 30X105
 1856.76 GR/M
 WT-2.15 mm

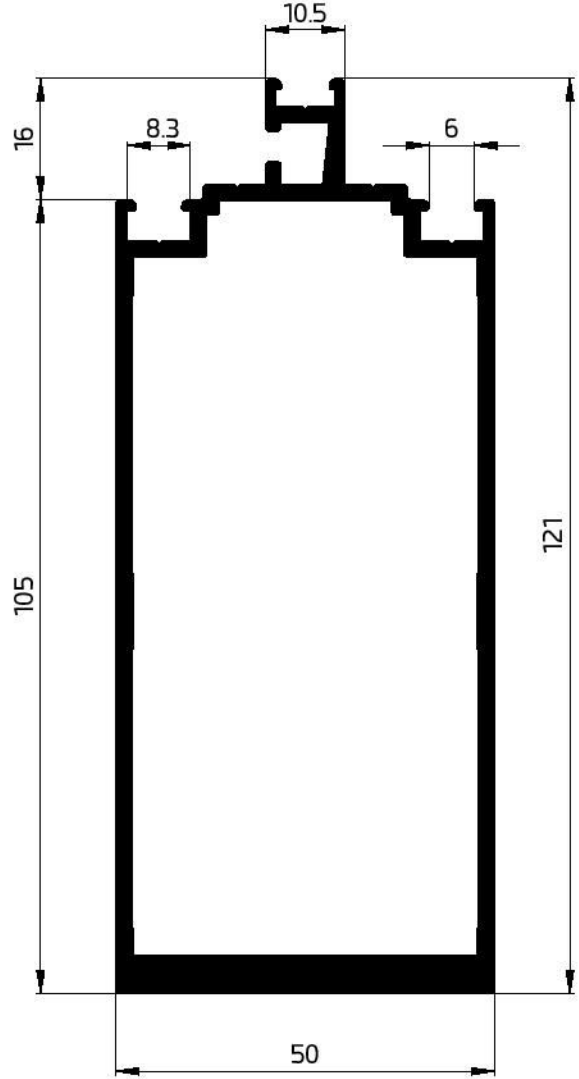

55028
 CW-TRANSOM 50X105
 2360.61GR/M
 WT-2.15 mm

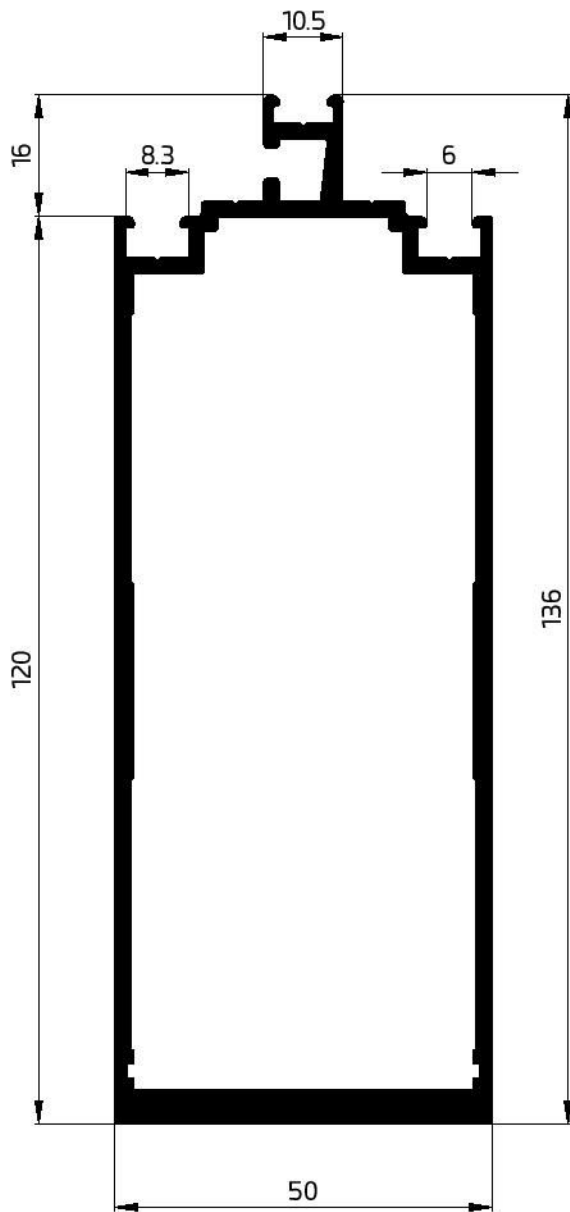

55043
 CW-TRANSOM 50X120
 2543.66 GR/M
 WT-2.2 mm

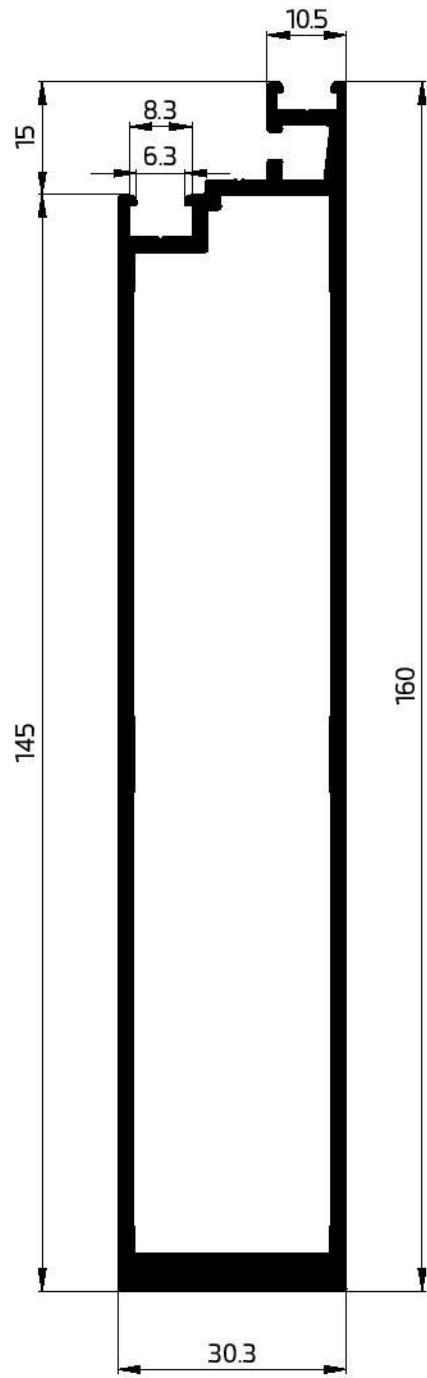

55045
 CW-END TRANSOM 30X145
 2407.47 GR/M
 WT-2.15 mm

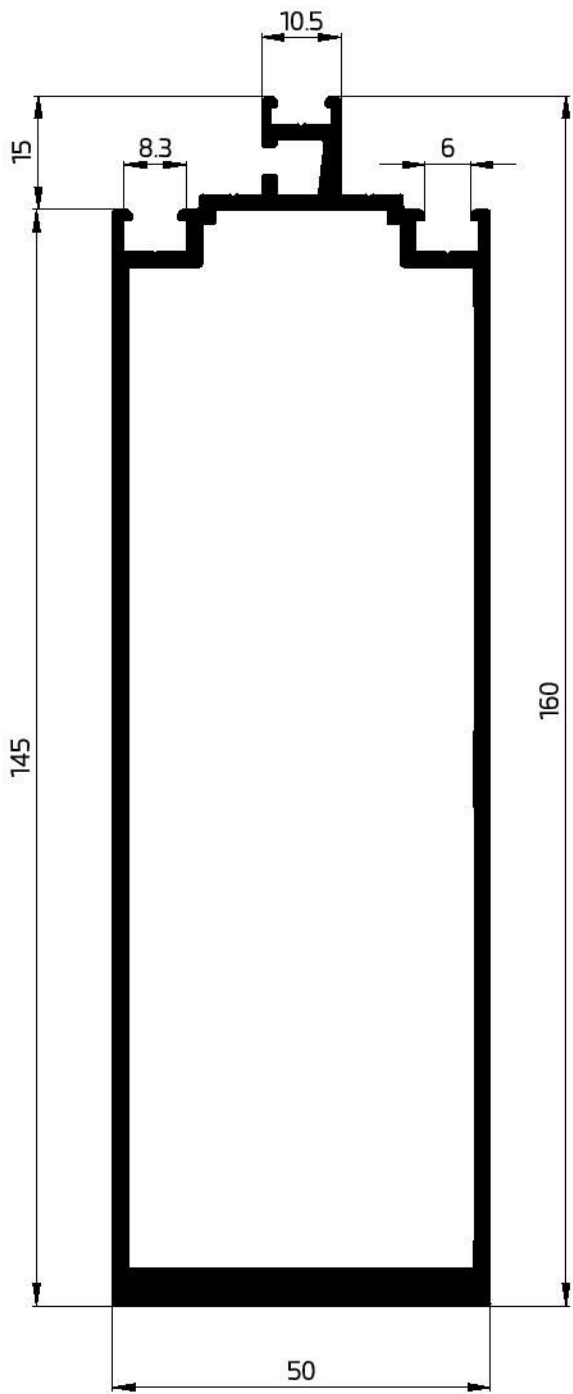

55044
 CW-TRANSOM 50X145
 2816.52 GR/M
 WT-2.15 mm

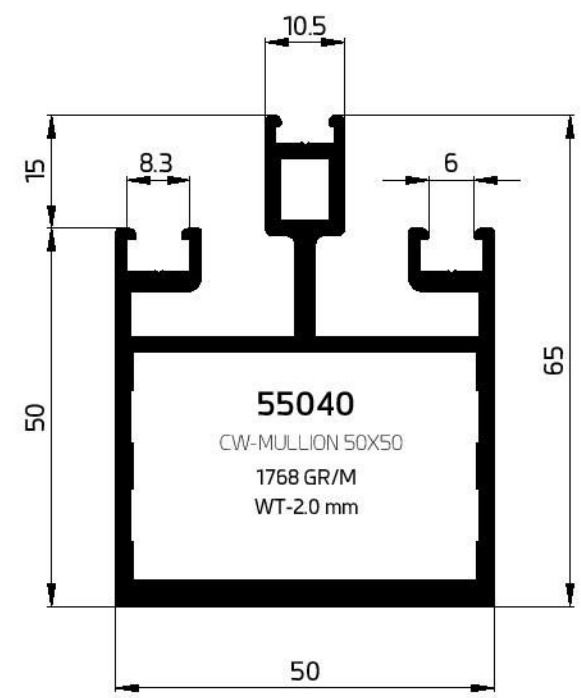

55040
 CW-MULLION 50X50
 1768 GR/M
 WT-2.0 mm

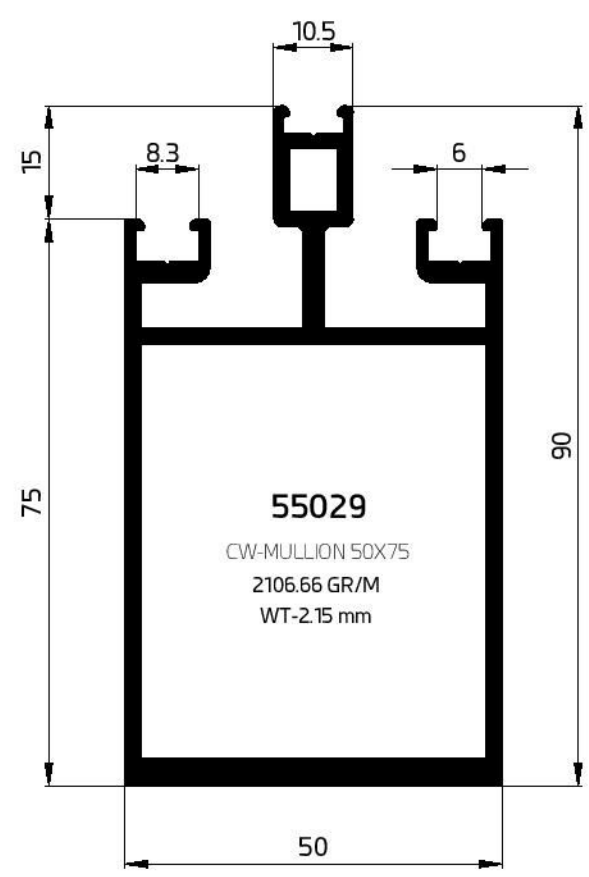

55029
 CW-MULLION 50X75
 2106.66 GR/M
 WT-2.15 mm

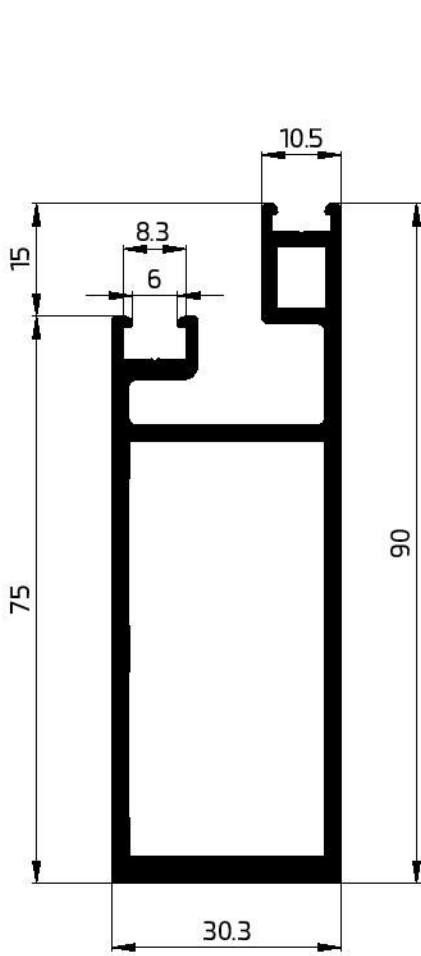

55025
 CW-END MULLION 30X75
 1605.28 GR/M
 WT-2.15 mm

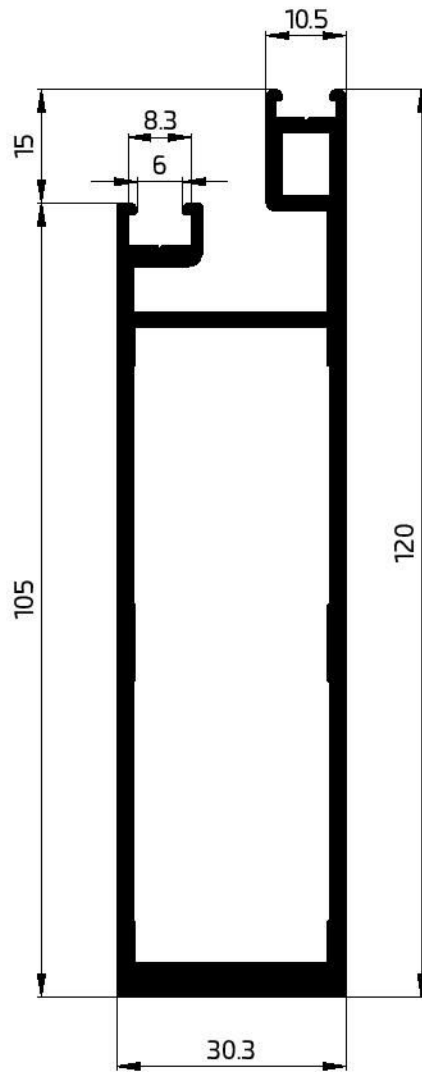

55049
 CW-END MULLION 30X105
 2048.57 GR/M
 WT-2.2 mm

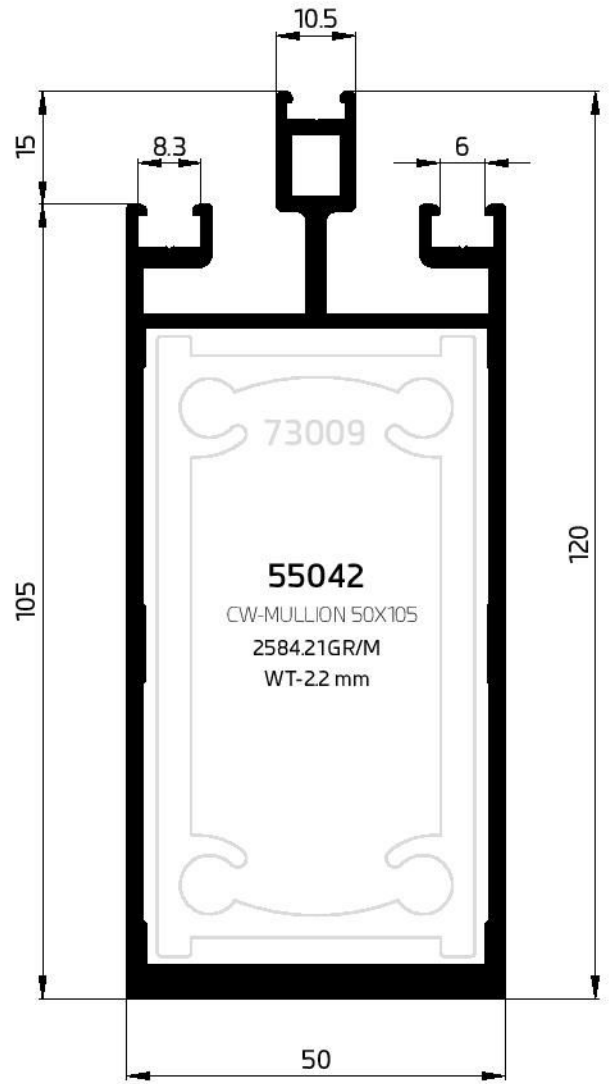
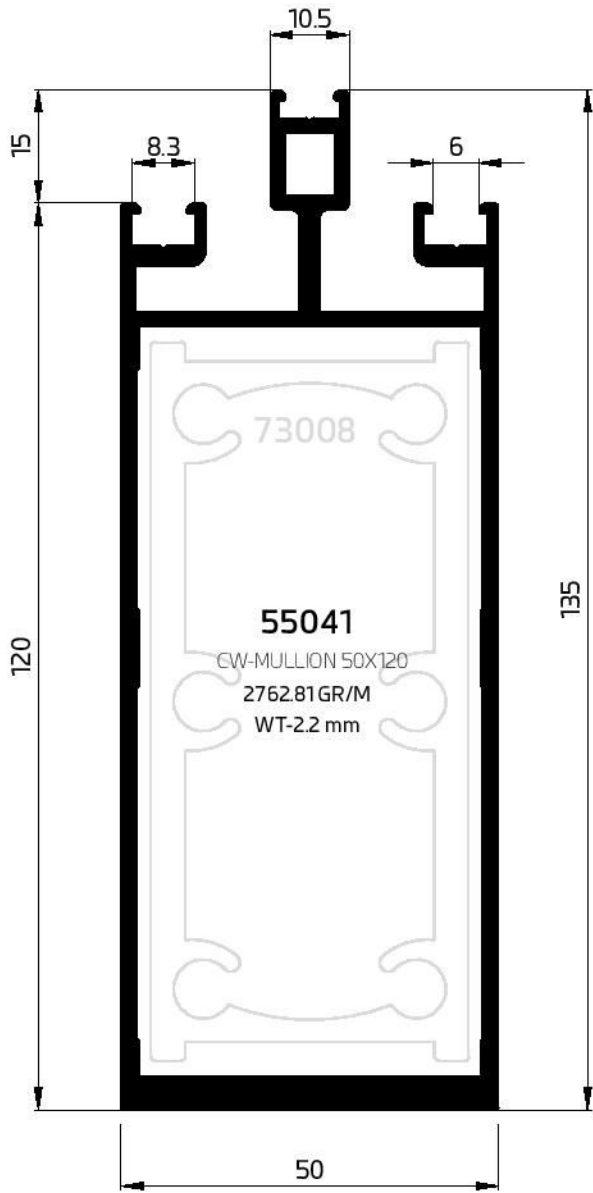

CURTAIN WALL

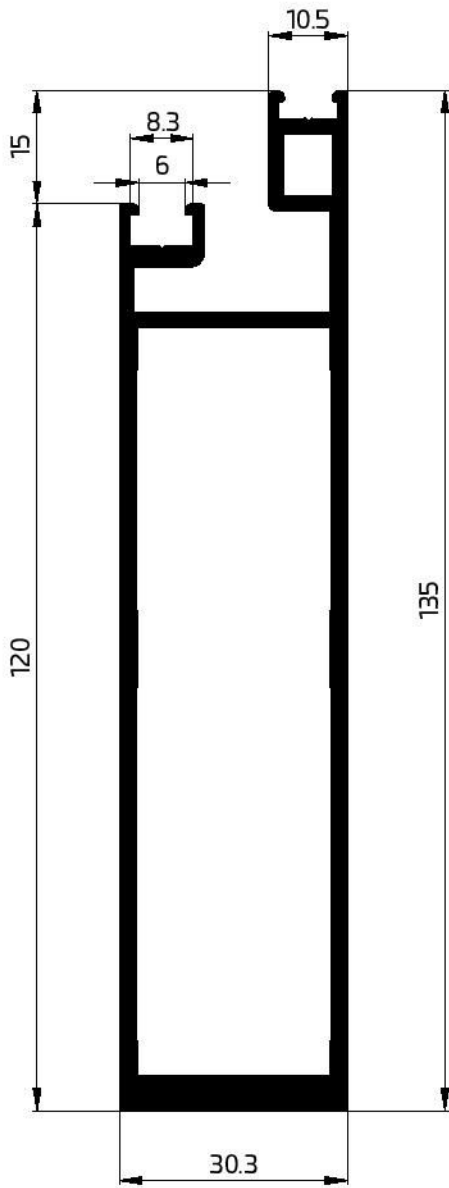

55048

CW-END MULLION 30X120

2238.90 GR/M

WT-2.2 mm

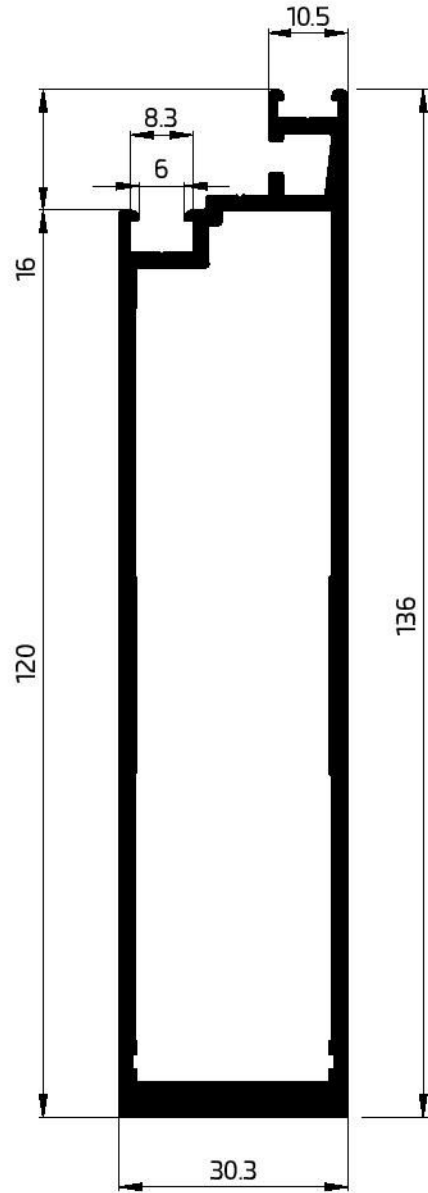

55050

CW-END TRANSOM 30X120

2159.54 GR/M

WT-2.2 mm

CURTAIN WALL

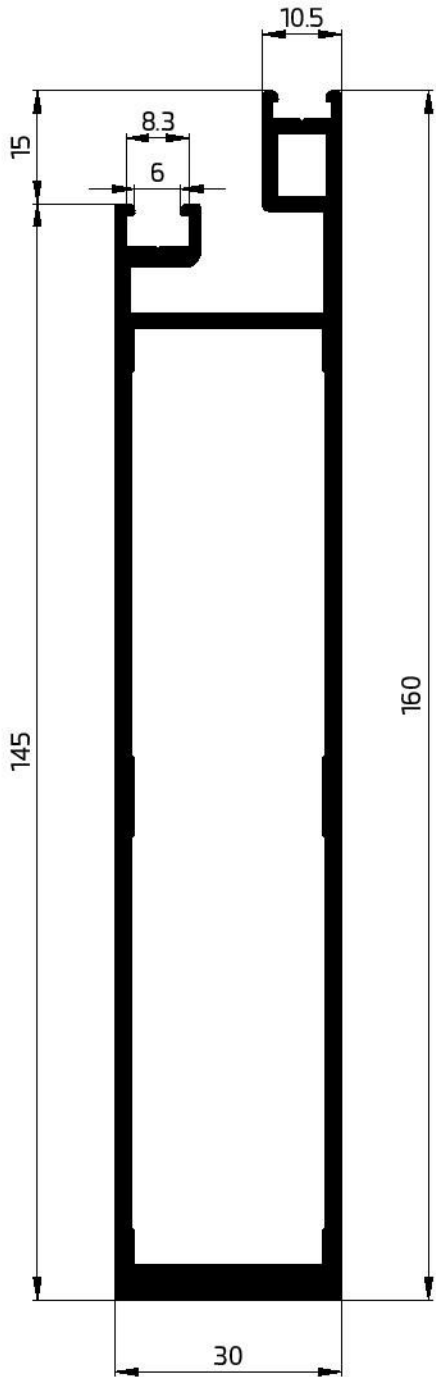

53002
 CW-END MULLION 30X145
 2550.88 GR/M
 WT-2.2 mm

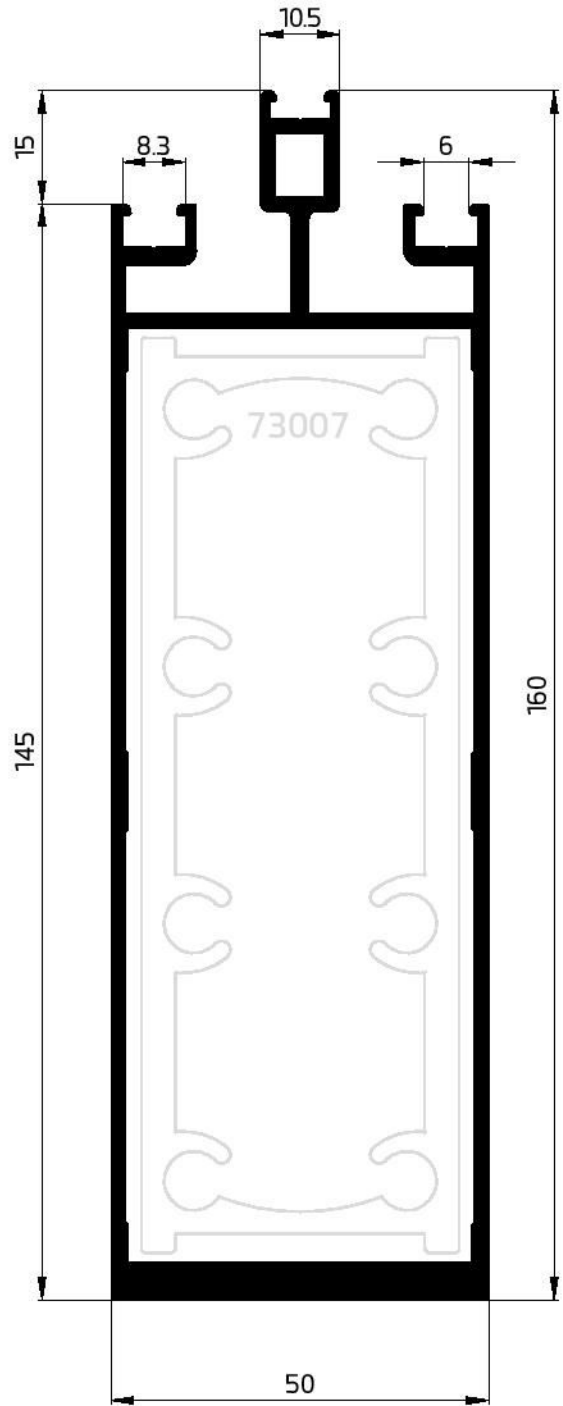

52027
 CW-MULLION 50X145
 3000 GR/M
 WT-2 mm

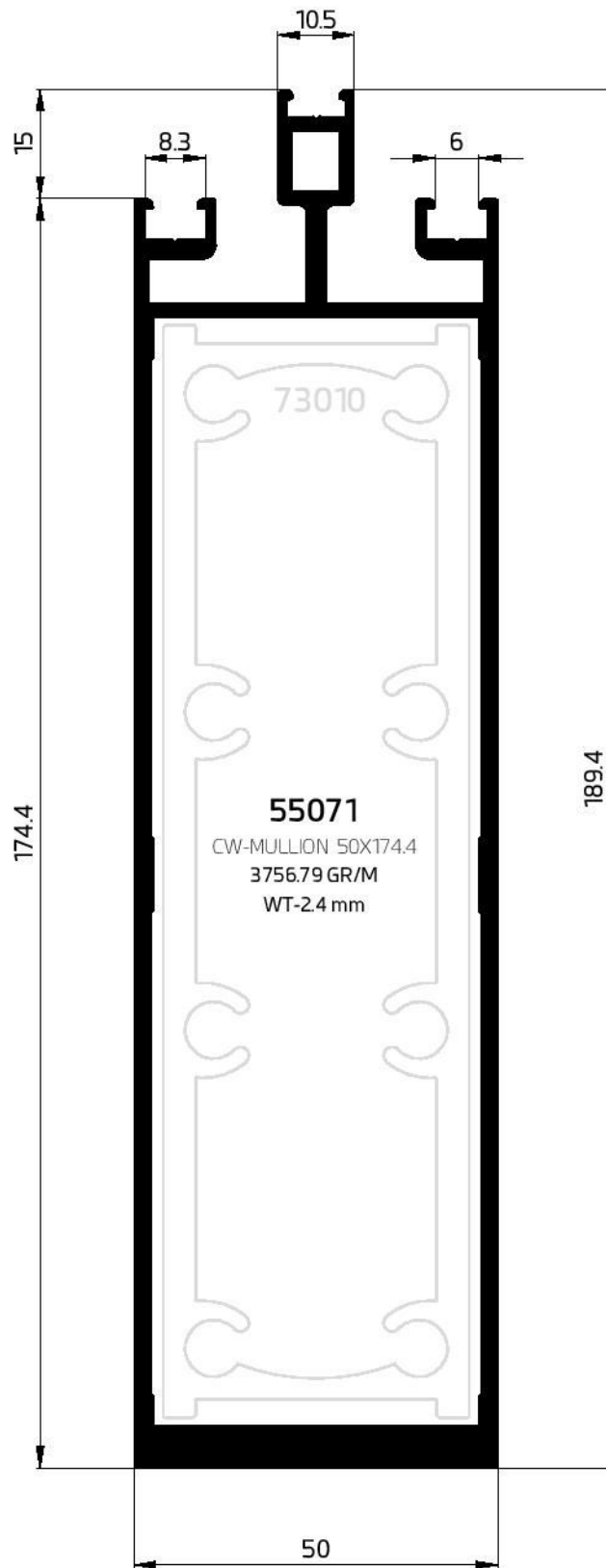

CURTAIN WALL

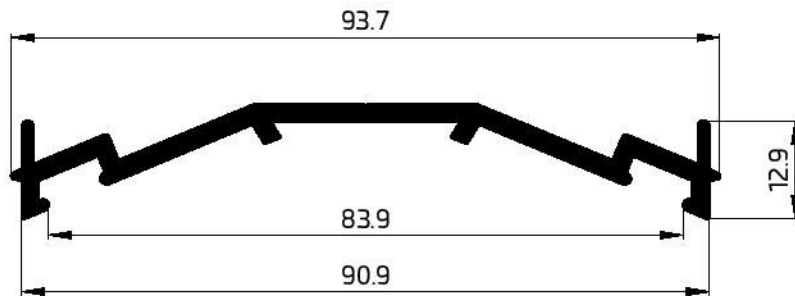

55052
CW-PRESSURE PLATE
785.98 GR/M
WT-2.35 mm

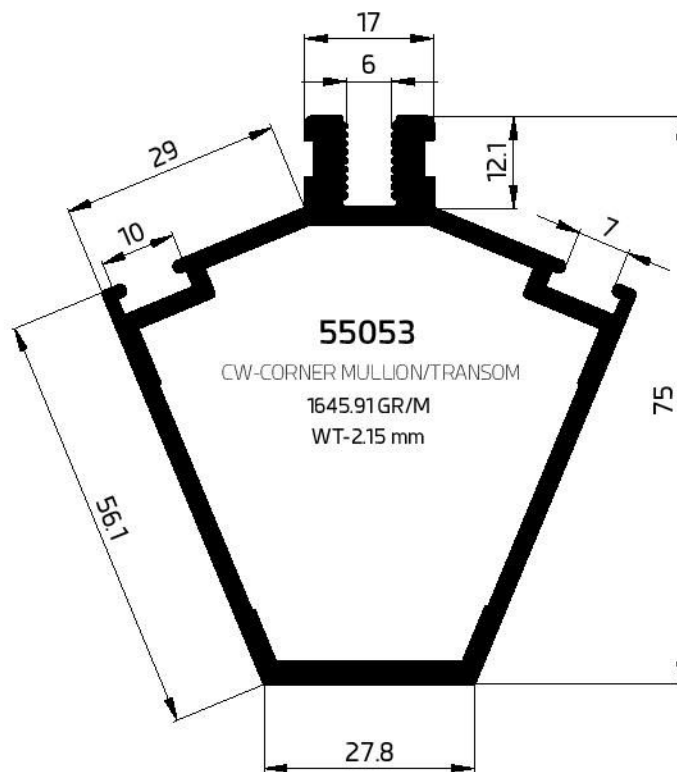

CURTAIN WALL

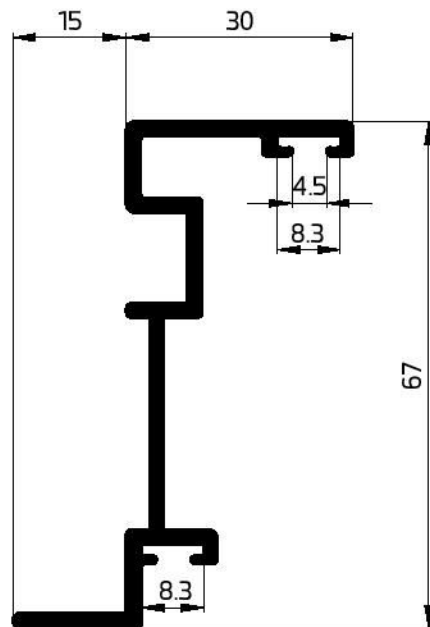
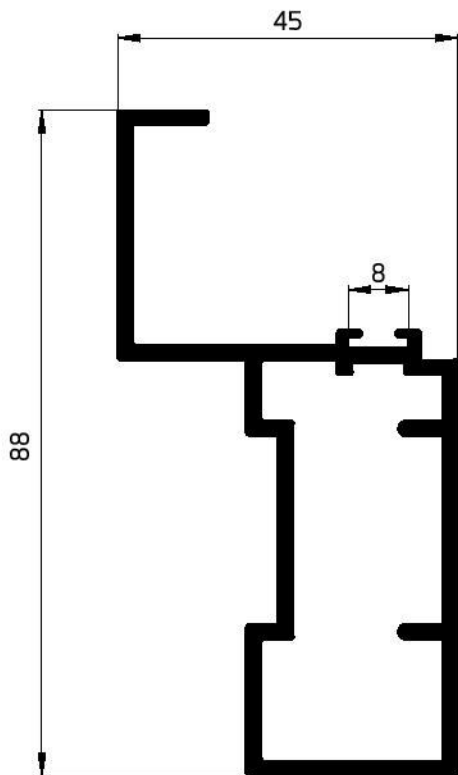
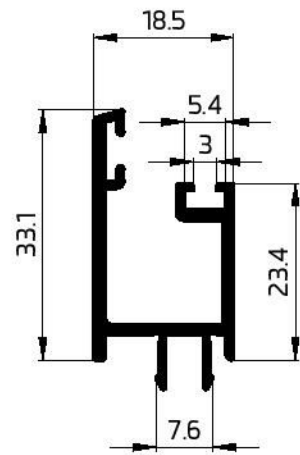
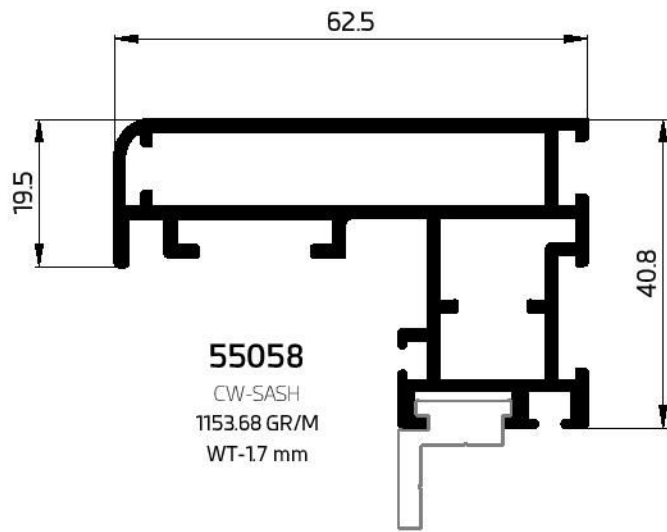

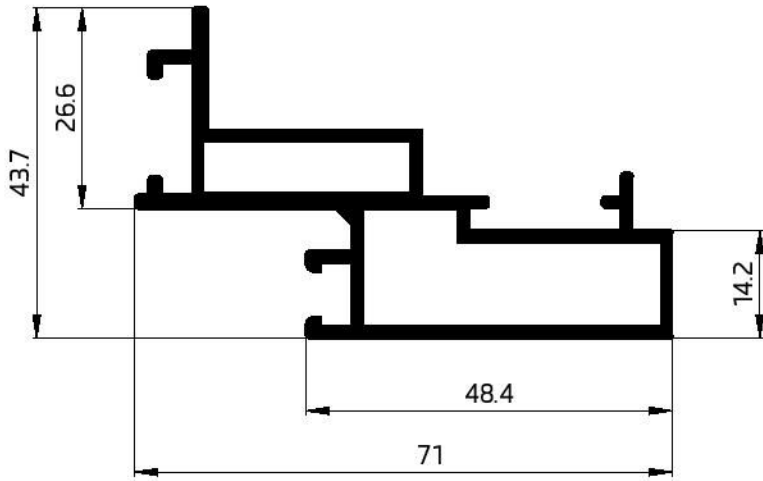

55056
 CW-SASH
 1041.30 GR/M
 WT-15 mm

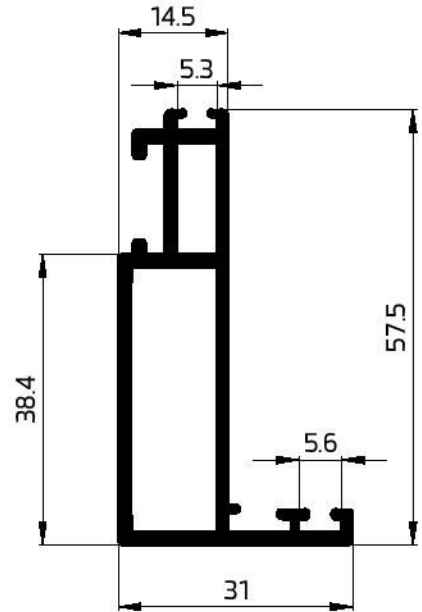

55057
 CW-FRAME
 767.83 GR/M
 WT-14 mm

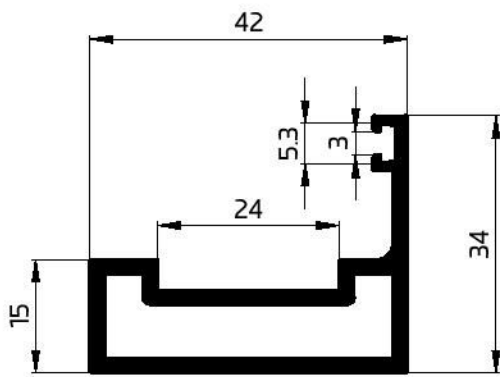

52001
 CW-SASH
 733.78 GR/M
 WT-2.0 mm

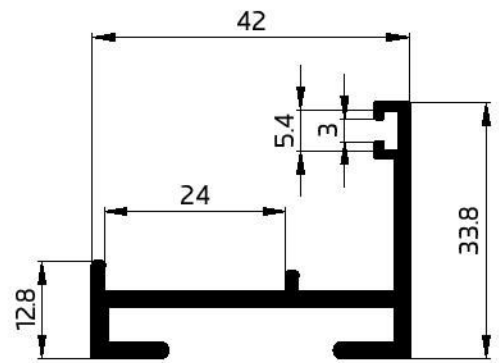

52000
 CW-FRAME
 559.91 GR/M
 WT-2.0 mm